



**CANADIAN AUTOMOBILE SPORT CLUBS  
ONTARIO REGION**

**2022 Race Regulations d5**

**Effective March 6, 2022**

---

This page intentionally left blank

DRAFT



## 2022 Race Regulations

© All material in this document is strictly the copyright of CASC Ontario Region and may not be reproduced without prior written permission.

These regulations are intended to assist in the conduct of Competitions and to further general safety. They are a guide and in no way guarantee against injury or death to participants, spectators or others. No express or implied warranties of safety or fitness for a particular purpose shall be intended or result from publication or compliance with these regulations. By applying for a competition licence and/or by entering a competition event, all participants are deemed to have understood and accepted these terms, including that motorsport is inherently dangerous and it is each participant's obligation to meet and maintain compliance with all regulations to reduce the risk of death or injury to self or others, recognizing that such risk is inherent to the sport and cannot be completely eliminated.

***Red bold, italics text indicates significant changes or amendments.***

### CANADIAN AUTOMOBILE SPORT CLUBS ONTARIO REGION

7250 Keele Street  
Suite 413  
Concord, ON  
L4K 1Z8  
CANADA

Tel: (416) 667 9500  
Fax: (416) 667 9555  
Toll-Free In Canada: (877) 667-9505

office@casc.on.ca  
<http://casc.on.ca/>

---

# Contents

<b>2022 RACE REGULATIONS</b> .....	<b>13</b>
1 REGULATIONS.....	13
1.1 APPLICATION OF THESE REGULATIONS.....	13
1.2 ALTERNATION OF THESE REGULATIONS.....	13
2 EVENTS.....	13
2.1 ORGANIZATION OF EVENTS.....	13
2.2 CLASSIFICATION OF EVENTS.....	15
2.3 GRIDDING AND STARTING.....	15
2.4 PACE/SAFETY CAR - GENERAL REQUIREMENTS.....	19
2.5 GUIDELINES FOR PACE CAR STARTS.....	20
2.6 RESTART PROCEDURE.....	20
2.7 SCORING OF PACED LAPS.....	21
3 ENTRANTS AND DRIVERS.....	21
3.1 CASC-OR RACE LICENCES.....	21
3.2 PRESENTATION OF LICENCE.....	21
3.3 PREFERRED NAMES.....	21
3.4 MEDICAL RESPONSIBILITY OF DRIVER.....	21
4 OFFICIALS.....	22
4.1 CHIEF OFFICIALS.....	22
4.2 REQUIRED OFFICIALS.....	22
4.3 DUTIES OF THE CLERK OF THE COURSE.....	22
4.4 DUTIES OF THE SECRETARY OF THE MEETING.....	23
4.5 DUTIES OF THE CHIEF TIMEKEEPER.....	24
4.6 DUTIES OF THE CHIEF SCRUTINEER.....	24
4.7 DUTIES OF THE CHIEF PIT LANE OFFICIAL.....	24
4.8 DUTIES OF THE CHIEF STARTER.....	25
4.9 DUTIES OF THE CHIEF MEDICAL OFFICER.....	25
4.10 DUTIES OF THE JUDGES OF FACT.....	25
4.11 DUTIES OF OBSERVERS.....	25
4.12 DUTIES OF THE CHIEF GRID MARSHAL.....	25
4.13 DUTIES OF THE CHIEF REGISTRAR.....	25
4.14 DUTIES OF THE CHIEF COURSE MARSHAL.....	26
4.15 DUTIES OF THE EVENT CHIEF INSTRUCTOR.....	26
4.16 DUTIES OF THE EMERGENCY SERVICES OFFICER.....	26
<b>APPENDIX A – RACE SCHOOLS</b> .....	<b>27</b>
1 GENERAL PROVISIONS FOR RACE SCHOOLS.....	27
1.1 ORGANIZATION OF RACE SCHOOLS.....	27
1.2 STUDENT REQUIREMENTS.....	27
2 COURSE ORGANIZATION.....	27
2.1 REGIONAL CHIEF Race Coach / INSTRUCTOR.....	27
2.2 THE DUTIES OF THE REGIONAL CHIEF Race Coach / INSTRUCTOR.....	27
2.3 Coach / INSTRUCTORS.....	28
2.4 PERMIT REQUIREMENTS.....	28
2.5 PRACTICAL INSTRUCTION.....	28
2.6 COMPETITION LICENCE APPLICATION FOR GRADUATES.....	28
3 REQUIRED SERVICES.....	28
4 PROFESSIONALLY ORGANIZED DRIVER SCHOOLS.....	28
4.1 APPROVAL OF PROFESSIONALLY ORGANIZED SCHOOLS.....	28
4.2 AVAILABILITY OF PROFESSIONAL SCHOOL INFORMATION.....	29
4.3 APPLICATION FOR Professional SCHOOL APPROVAL.....	29
<b>APPENDIX B – FEES AND MINIMUM PENALTIES</b> .....	<b>30</b>

---

1	FEES .....	30
1.1	PROTEST FEE .....	30
1.2	APPEAL FEE.....	30
1.3	SANCTION AND PERMIT FEES .....	30
2	RECOMMENDED MINIMUM PENALTIES.....	30
2.1	PASSING IN A YELLOW ZONE .....	30
2.2	ILLEGAL SAFETY EQUIPMENT (CLOTHING).....	31
2.3	UNDERWEIGHT CARS.....	31
2.4	VIOLATION OF THE PIT OUT BLEND LINE .....	31
2.5	VIOLATION OF THE PIT LANE SPEED LIMIT .....	31
2.6	FAILURE TO OBEY A BLACK FLAG .....	31
2.7	Take Two Checkered or Red Flags.....	31
2.8	Failure to obey officials.....	32
2.9	JUMP OR FALSE START .....	32
2.10	REFUSING TO DISASSEMBLE .....	32
2.11	TOW HOOK / STRAP .....	32
	<b>APPENDIX C - GLOSSARY .....</b>	<b>33</b>
	<b>APPENDIX D – PROTESTS AND APPEALS .....</b>	<b>35</b>
1	PROTESTS AGAINST RACE OFFICIALS .....	35
2	PROCEDURAL PROTESTS.....	35
3	PROTEST OF RESULTS .....	35
4	TIME LIMITS.....	35
5	PUBLICATION OF RESULTS.....	35
	<b>APPENDIX E - LICENCES .....</b>	<b>36</b>
1	RACE DRIVER LICENCES.....	36
1.1	PRESENTATION OF LICENCES .....	36
1.2	RESIDENCY REQUIREMENTS .....	36
1.3	ACCUS RACE LICENCES .....	36
1.4	RACE LICENCES FROM OTHER SANCTIONING BODIES .....	36
1.5	PARENTAL PERMISSION .....	36
1.6	MINIMUM AGE REQUIREMENTS .....	36
1.7	REDUCTION OF GRADE, SUSPENSION OR WITHDRAWAL OF LICENCE .....	36
1.8	UNLICENCED ENTRY IN COMPETITION .....	37
1.9	EXPIRY OF COMPETITION LICENCES.....	37
1.10	ELIGIBILITY BY EVALUATION .....	37
2	RACE LICENCE MEDICAL CERTIFICATES.....	37
2.1	MEDICAL REQUIREMENTS FOR COMPETITION .....	37
2.2	MEDICAL EXAMINATION.....	37
2.3	ACCEPTED DOCUMENTATION.....	38
2.4	VALIDITY OF MEDICAL CERTIFICATES.....	38
3	RACE LICENCE GRADES .....	38
3.1	PROBATIONARY RACE LICENCE .....	38
3.2	REGIONAL Race LICENCE.....	38
3.3	TEMPORARY RACE LICENCE .....	38
3.4	RACE LICENCE REQUIREMENTS AND PROGRESSION .....	38
4	RACE LICENCE FEES.....	39
5	RACE OFFICIALS’ LICENCES .....	39
5.1	OFFICIALS’ LICENCE GRADES.....	39
5.2	OFFICIALS’ LICENCE REQUIREMENTS.....	39
5.3	STEWARD, CLERK AND SCRUTINEER LICENCE REQUIREMENTS AND PROGRESSION .....	40
5.4	PIT OFFICIAL LICENCE REQUIREMENTS AND PROGRESSION .....	40
5.5	MARSHAL REQUIREMENTS AND PROGRESSION.....	40
5.6	ACCREDITED MARSHALING CLUB .....	42
6	DEFINITIONS.....	42

<b>APPENDIX F – MEDICAL, FIRE AND RESCUE</b> .....	<b>43</b>
1 EQUIPMENT, VEHICLES AND PERSONNEL .....	43
2 OPERATING RULES.....	43
3 MEDICAL, FIRE AND RESCUE – MINIMUM REQUIREMENTS .....	43
3.1 MINIMUM REQUIRED VEHICLES .....	43
3.2 MINIMUM EQUIPMENT FOR FIRE VEHICLES.....	44
3.3 MINIMUM EQUIPMENT FOR RESCUE VEHICLES.....	44
3.4 MINIMUM EQUIPMENT FOR TRACK AMBULANCES .....	44
3.5 MINIMUM EQUIPMENT FOR CORNER STATIONS .....	45
4 RACE MEDICAL.....	45
<b>APPENDIX G – RULES OF THE PITS AND PADDOCK</b> .....	<b>46</b>
1 PITS.....	46
1.1 PROVISION OF PITS .....	46
1.2 CHILDREN .....	46
1.3 ACCESS .....	46
1.4 RACE START.....	46
1.5 APPAREL.....	46
1.6 SMOKING.....	46
1.7 SPACE ALLOTTED.....	46
1.8 CARS OVERSHOOTING THE PIT .....	46
1.9 FIRE EXTINGUISHER REQUIREMENTS .....	46
1.10 PETS.....	47
1.11 PIT LANE SPEED LIMIT.....	47
1.12 PHOTOGRAPHY.....	47
1.13 BLEND LINE.....	47
1.14 AUXILIARY POWER .....	47
1.15 EMERGENCY/SERVICE VEHICLES IN PIT LANE .....	47
1.16 DRIVER CREW AT PIT WALL.....	47
1.17 DRIVER CREW DURING PIT-IN.....	47
1.18 DRIVER CREW DURING PIT STOP .....	47
1.19 JACK STANDS.....	47
2 FUEL STORAGE AND REFUELING.....	47
3 STORAGE CYLINDERS FOR COMPRESSED GAS .....	48
4 PADDOCK.....	48
4.1 FACILITIES.....	48
4.2 PETS.....	48
4.3 CHILDREN .....	48
4.4 NOISE REGULATION .....	48
4.5 RACETRACK PERMISSION.....	48
4.6 PADDOCK ROADS .....	48
4.7 FIRE EXTINGUISHERS.....	48
4.8 MOTORIZED VEHICLES .....	48
<b>APPENDIX H – FLAG AND LIGHT SIGNALS AND RULES OF THE ROAD</b> .....	<b>50</b>
1 GENERAL.....	50
2 FLAG SIGNALS: MINIMUM SIZE.....	50
3 FLAGS USED EXCLUSIVELY ON THE INSTRUCTIONS OF THE CLERK .....	50
3.1 STARTING FLAG.....	50
3.2 BLACK AND WHITE - CHECKERED FLAG.....	50
3.3 RED FLAG.....	50
3.4 BLACK FLAG.....	50
3.5 BLACK AND WHITE FLAG.....	50
3.6 BLACK FLAG WITH ORANGE DISK – 'MECHANICAL BLACK FLAG'.....	50
3.7 USE OF THE STARTER'S STAND AS A FLAG STATION.....	51
4 FLAGS USED AT MARSHALS' POSTS .....	51

4.1	YELLOW FLAG.....	51
4.2	YELLOW FLAG WITH RED STRIPES.....	52
4.3	GREEN FLAG.....	52
4.4	WHITE FLAG.....	52
4.5	BLUE FLAG.....	52
5	LIGHT SIGNALS.....	52
5.1	SPECIFICATIONS.....	52
5.2	MEANINGS.....	52
5.3	REQUIREMENTS FOR NIGHT RACING.....	52
6	SIGNBOARDS USED BY THE STARTER.....	52
7	RULES OF THE ROAD.....	53
7.1	ENTERING THE PITS.....	53
7.2	SIGNALING TO PASS.....	53
7.3	DIRECTION OF TOW.....	53
7.4	STOPPING ON THE COURSE.....	53
7.5	MOVEMENT UNDER POWER OF THE VEHICLE STARTER.....	53
7.6	ASSISTANCE.....	53
7.7	DRIVING OFF COURSE.....	53
7.8	OVERTAKING.....	53
7.9	REPETITION OF DRIVING ERRORS.....	53
7.10	RIDING OUTSIDE THE COCKPIT AREA.....	54
7.11	DRIVER SIGNAL AFTER AN ON-TRACK INCIDENT.....	54
7.12	DROPPING OIL.....	54
7.13	Driving a Disabled Car.....	54
<b>APPENDIX I – DRIVER SAFETY EQUIPMENT.....</b>		<b>55</b>
1	USE OF DRIVER SAFETY EQUIPMENT.....	55
2	CLOTHING.....	55
2.1	DRIVER SUITS AND UNDERWEAR.....	55
2.2	GLOVES.....	55
2.3	SOCKS.....	56
2.4	SHOES.....	56
2.5	BALACLAVAS AND HELMET SKIRTS.....	56
2.6	HELMETS.....	56
2.7	FHR (FRONTAL HEAD RESTRAINT) DEVICES.....	56
3	APPROVED MATERIALS.....	56
4	DRIVER SUITS AND UNDERWEAR SYSTEMS.....	57
4.1	APPROVED SYSTEMS.....	57
4.2	RESTRICTED MATERIALS.....	57
4.3	PROOF OF COMPLIANCE.....	57
5	EYE PROTECTION - RECOMMENDATIONS.....	57
<b>APPENDIX J – TECHNICAL INSPECTION.....</b>		<b>58</b>
1	CAR LOGBOOKS.....	58
1.1	RECOGNIZED LOGBOOKS.....	58
1.2	VALID LOGBOOKS.....	58
1.3	ISSUANCE OF LOGBOOKS.....	58
1.4	IDENTITY PLATE.....	58
2	TECHNICAL AND SAFETY INSPECTION.....	58
2.1	ANNUAL INSPECTION.....	58
2.2	INSPECTION AT EVENTS.....	58
2.3	CLASS SCRUTINEERING.....	59
2.4	RANDOM SCRUTINEERING.....	59
3	OFFICIAL SCALES.....	59
3.1	DESIGNATION.....	59
3.2	CAR WEIGHT.....	59
4	IMPOUND.....	59

4.1	NOTICE OF IMPOUND .....	59
4.2	RESPONSIBILITY.....	59
4.3	SUPERVISION.....	60
4.4	FINDINGS.....	60
4.5	POSTPONEMENT OF DISASSEMBLY AND INSPECTION.....	60
5	PROTESTS AND TEARDOWN BONDS.....	60
5.1	ELIGIBILITY FOR PROTEST.....	60
5.2	TEARDOWN.....	60
5.3	COMPLETION OF TEARDOWN.....	60
5.4	WHERE LEGALITY IS DETERMINED BY TEARDOWN .....	60
5.5	WHERE ILLEGALITY IS DETERMINED BY TEARDOWN.....	61
6	MEASUREMENTS .....	61
6.1	IMPOUND.....	61
6.2	RESPONSIBILITIES.....	61
<b>APPENDIX K – FUEL, FUEL CELLS AND TANKS .....</b>		<b>62</b>
1	FUEL.....	62
1.1	PERMITTED FUELS.....	62
1.2	ADDITIVES .....	62
2	FUEL CELLS/TANKS.....	62
2.1	DEFINITION.....	62
2.2	CLASS REQUIREMENTS.....	62
2.3	SIZE, NUMBER AND CAPACITY .....	62
2.4	LOCATION.....	62
2.5	DESIGN DETAILS AND MATERIAL SPECIFICATIONS .....	63
<b>APPENDIX L – DRIVER RESTRAINT SYSTEMS.....</b>		<b>64</b>
1	GENERAL PROVISIONS.....	64
2	DESIGN.....	64
3	MATERIALS .....	64
4	INSTALLATION .....	64
5	FUNCTION.....	64
6	HARDWARE.....	64
7	VALIDITY .....	65
<b>APPENDIX M – ROLL CAGES .....</b>		<b>66</b>
1	GENERAL.....	66
1.1	APPLICATION.....	66
1.2	DESIGN .....	66
2	BASIC DESIGN CONSIDERATIONS.....	66
2.1	PURPOSE .....	66
2.2	INSIDE DIMENSIONS.....	66
2.3	OPERATION .....	66
2.4	HEAD RESTRAINT.....	66
2.5	PADDING .....	66
2.6	AERODYNAMIC RESTRICTIONS.....	67
2.7	ENGINE INTRUSION.....	67
3	DIMENSIONS AND MATERIALS .....	67
3.1	MATERIALS.....	67
3.2	DIMENSIONS .....	67
3.3	WEIGHT.....	67
3.4	MINUS TOLERANCE.....	67
3.5	INSPECTION HOLE .....	68
4	FABRICATION.....	68
4.1	BENDS.....	68
4.2	MAIN HOOPS.....	68



4.3	JOINTS.....	68
4.4	BRAZING.....	68
5	FORMULA AND SPORTS RACING CARS.....	68
5.1	GENERAL.....	68
5.2	MAIN AND FRONT HOOPS.....	68
5.3	BRACING.....	70
6	ALL CLOSED-WHEEL CARS.....	70
6.1	GENERAL.....	70
6.2	MAIN AND FRONT HOOPS.....	70
6.3	BRACING.....	70
6.4	SIDE PROTECTION.....	71
6.5	MOUNTING PLATES.....	71
6.6	SEAT BACK MOUNTING.....	71
7	ALTERNATIVE ROLL CAGE DESIGNS.....	71
7.1	CERTIFICATION.....	71
7.2	COMPOSITES.....	72
8	INCREASING ROLL CAGE HEIGHT.....	72
9	ROLL CAGE DIAGRAMS.....	72
9.1	FORMULA CARS.....	72
9.2	GT, OPEN GT CARS, AND SPORTS RACERS.....	73
9.3	REMOVABLE BRACE DETAILS.....	74
<b>APPENDIX N – CAR PREPARATION.....</b>		<b>75</b>
1	SCOPE OF REGULATIONS.....	75
2	GENERAL PROVISIONS.....	75
3	APPEARANCE.....	75
3.1	PRESENTATION.....	75
4	NUMBERS, MARKINGS AND ADVERTISING.....	75
4.1	IDENTIFICATION NUMBERS AND CLASS DESIGNATORS.....	75
4.2	CASC-OR IDENTIFICATION.....	77
4.3	ADVERTISING.....	79
5	SAFETY.....	79
5.1	ROLL CAGE.....	79
5.2	DRIVER RESTRAINTS.....	79
5.3	WINDOW NETS.....	79
5.4	MASTER ELECTRICAL SWITCH.....	80
5.5	SCATTERSHIELDS.....	81
5.6	CHAIN-DRIVE CARS.....	81
5.7	DRIVE SHAFT LOOPS.....	81
5.8	ON-BOARD FIRE SYSTEMS.....	81
5.9	FUEL CONTAINMENT.....	81
5.10	DRIVER TETHERING.....	81
6	FORMULA CAR VISIBILITY.....	81
6.1	GENERAL PROVISIONS.....	81
7	WEIGHT.....	82
7.1	GENERAL PROVISIONS.....	82
7.2	BALLAST.....	82
8	FUEL.....	82
9	BODYWORK.....	82
9.1	POSITIONING.....	82
9.2	FENDERS.....	82
9.3	MIRRORS.....	82
9.4	DETACHABLE PANELS.....	82
9.5	HOOD.....	82
9.6	TONNEAU AND BOOT COVERS.....	82
9.7	NOSE COVERS.....	82
9.8	SUNROOFS.....	82

9.9	T-BAR ROOFS.....	83
9.10	OPEN GT CARS.....	83
9.11	DRIVER/PASSENGER COMPARTMENT .....	83
9.12	BUMPERS .....	83
9.13	FENDERS.....	83
9.14	WINDOW TINTING .....	83
9.15	WINDOW MATERIALS .....	83
9.16	WINDOW CLIPS AND REAR WINDOW STRAPS.....	83
9.17	WINDSHIELDS FOR OPEN GT CARS .....	84
9.18	AERODYNAMIC DEVICES FOR GT CARS.....	84
10	TIRES .....	84
11	LIGHTS.....	84
11.1	BRAKE LIGHTS .....	84
11.2	RAIN LIGHT.....	84
11.3	FORMULA CARS.....	84
12	BRAKES.....	84
13	THROTTLE SPRINGS.....	84
14	EXHAUST .....	85
14.1	CATALYTIC CONVERTERS.....	85
14.2	EXHAUST SYSTEM TERMINATION .....	85
15	STARTERS .....	85
16	BATTERIES.....	85
17	OIL ACCUMULATORS/TANKS .....	85
18	FUEL CAPS, LINES AND VENTS, OIL LINES, WATER LINES.....	85
18.1	LEAKAGE.....	85
18.2	DRIVER/PASSENGER COMPARTMENT PLUMBING .....	85
18.3	FILLER CAP.....	85
18.4	FLIP-TOP CAPS.....	86
18.5	FUEL TANK AIR VENTS.....	86
18.6	FUEL TANK VENTS IN OPEN GT CARS.....	86
18.7	LOCATION OF FITTINGS.....	86
18.8	ON FORMULA AND SPORTS RACING CARS .....	86
18.9	HEADER TANKS.....	86
18.10	WATER LINES.....	86
19	CATCH TANKS AND BREATHERS .....	86
20	INTERIOR.....	86
20.1	SEAT MOUNTING .....	86
20.2	PASSENGER SEATBACKS.....	87
20.3	STEERING WHEEL MATERIALS.....	87
20.4	ANCILLARY MOTORING EQUIPMENT.....	87
20.5	INTERIOR TRIM.....	87
20.6	INTERIOR DOOR PANELS.....	87
21	VENTILATION AND ACCESS .....	87
22	FIREWALL AND FLOOR .....	87
23	AIR BAGS .....	87
24	CRUISE CONTROLS .....	87
25	VIDEO EQUIPMENT .....	87
26	RADIO COMMUNICATION AND TELEMETRY.....	87
26.1	TELEMETRIC SIGNALS.....	87
26.2	ALLOWABLE COMMUNICATIONS.....	88
26.3	RADIO COMMUNICATIONS.....	88
26.4	MAGNETICALLY MOUNTED ANTENNAS.....	88
26.5	OEM ANTENNAS.....	88
27	TOWING EYES/TOW STRAPS.....	88
27.1	INSTALLATION.....	88
28	SOUND LEVELS .....	88

29	ANTIFREEZE.....	89
30	TIMING TRANSPONDERS.....	89
<b>APPENDIX O – REGULATIONS AND SPECIFICATIONS FOR CAR CLASSES .....</b>		<b>90</b>
<b>APPENDIX P – RACE ONTARIO SERIES REGULATIONS .....</b>		<b>91</b>
1	GENERAL PROVISIONS.....	91
2	SCHEDULE.....	91
2.1	PUBLICATION OF EVENT SCHEDULES.....	91
2.2	ATTENDANCE AT DRIVERS’ MEETINGS .....	91
3	ENTRIES .....	91
3.1	OVER SUBSCRIPTION OF RACES.....	91
3.2	ISSUANCE OF SCRUTINEERING SHEETS.....	91
3.3	ISSUANCE OF NON-COLLECTIBLE PAYMENTS .....	91
3.4	DATE OF PAYMENT .....	92
3.5	ESTABLISHMENT OF ENTRY FEES .....	92
3.6	REFUND OF ENTRY FEES.....	92
3.7	REFUSAL OF ENTRY .....	92
3.8	PARTICIPANT WAIVER.....	92
3.9	COMBINATION OF RACE GROUPS.....	92
4	COMPETITOR ELIGIBILITY FOR SERIES POINTS AND AWARDS .....	92
4.1	COMPETITOR ELIGIBILITY.....	92
4.2	PIRELLI TIRE GT.....	92
5	CAR CLASSIFICATION .....	93
5.1	CAR CLASSES.....	93
5.2	CHAMPIONSHIP IDENTIFICATION .....	93
5.3	BACK-UP CARS.....	93
6	COMPETITOR INFORMATION .....	93
7	POINTS.....	93
7.1	SCORING.....	93
7.2	RACE POINTS SCORING APPLICATION.....	94
7.3	CLASS SCORING - MINIMUM.....	96
7.4	CLASS SCORING - MAXIMUM.....	96
7.5	CLASS SCORING – END-OF-YEAR SCORING .....	96
7.6	SCORING TIES.....	96
7.7	POINTS FUND DISTRIBUTION – PIRELLI TIRE GT .....	96
8	ANNUAL AWARDS.....	97
8.1	PRESENTATION OF TROPHIES.....	97
8.2	CAR NUMBER ‘1’ .....	97
8.3	ROOKIE AWARD .....	97
9	EVENT AWARDS.....	97
9.1	TROPHY PRESENTATION .....	97
9.2	CLASS REQUIREMENTS FOR AWARDING OF EVENT TROPHIES .....	97
9.3	ACCEPTANCE OF TROPHIES.....	97
<b>APPENDIX Q - ENDURANCE RACE REGULATIONS .....</b>		<b>98</b>
1	GENERAL.....	98
2	ENTRIES .....	98
3	DRIVERS' MEETING .....	98
4	GRIDDING .....	98
5	PIT SET UP.....	98
6	PIT PROCEDURES .....	98
6.1	SIXTY (60) MINUTE RACES.....	98
6.2	NINETY (90) MINUTE RACES.....	98
6.3	ONE HUNDRED AND TWENTY (120) MINUTE RACES.....	99
6.4	PIT PROCEDURES FOR RACES LONGER THAN 120 MINUTES .....	99

7 ON-TRACK REPAIR ..... 99

8 REFUELING..... 99

    8.1 REFUELING EQUIPMENT ..... 99

    8.2 REFUELING PROCEDURE ..... 99

9 PIT RULES..... 100

10 PENALTIES..... 100

**APPENDIX Z - CHANGES SINCE PREVIOUS YEAR ..... 102**

DRAFT

# 2022 RACE REGULATIONS

## 1 Regulations

### 1.1 APPLICATION OF THESE REGULATIONS

These Race Regulations shall govern all race Events sanctioned by CASC-OR. The recognized classes and Appendix sections of this book are an integral part of this book.

### 1.2 ALTERNATION OF THESE REGULATIONS

These Regulations were established by CASC-OR which reserves unto itself the right at any time to alter these Regulations, develop special rules in emergency and periodically to revise any appendices hereto. Such alterations or additions will be published in the form of revised manuals or bulletins.

## 2 Events

### 2.1 ORGANIZATION OF EVENTS

#### 2.1.1 COURSE LICENCE

- a) A Course Licence is required for each course approved for Competition.
- b) A permanent course shall have an annual Course Licence and a temporary course shall have an Event Course Licence.
- c) A permanent course shall be inspected prior to commencement of Competition each year in order to obtain a Licence.
- d) A temporary course shall be inspected prior to commencement of Competition in order to obtain a Licence.
- e) A request for inspection shall be made in writing to ASN Canada.
- f) Fees for inspection and licences are available from ASN Canada.
- g) A copy of the Course Licence, so long as it is in force, shall be displayed in a prominent position at the course and shall be made available for inspection by the Stewards of the Event.

#### 2.1.2 APPLICATION FOR EVENT SANCTION

Every application for a CASC-OR Event Sanction shall be submitted for approval on the official form and a minimum of four (4) weeks prior to the event. In the case of an Application for Event Sanction at a course which is not already approved by ASN Canada, the application shall be submitted at least two (2) months prior to the proposed Event and shall be accompanied by a full description of the course and facilities, including a scale map. Applications postmarked after the deadline shall be submitted with a late fee of 50 percent of the sanction fee.

Applications shall include:

- a) The name and address of the applicant;
- b) The organization, or person, on whose behalf the application is made, and the official position of the applicant;
- c) The date and place of the proposed Event;
- d) The nature and classification of the Event for which a sanction is requested;
- e) Copy of the entry form, Supplementary Regulations, and the schedule of events;

- f) The applicable Sanction Fee per the CASC-OR Sanction Fee Schedule (available at the CASC-OR office.)

### 2.1.3 SUPPLEMENTARY REGULATIONS

The Supplementary Regulations shall contain the following information:

- a) The name, location, dates, nature and classification of the proposed Event;
- b) Type of sanction for the Event;
- c) An announcement conspicuously placed: "Held under the CASC-OR General Competition Rules";
- d) The name and address of the organizers;
- e) The CASC-OR symbol in a conspicuous location;
- f) The names of the required Officials;
- g) All other information necessary for the proper conduct of the Event with no repetition of any CASC-OR rules;
- h) The location of scrutineering and impound;
- i) Definition of the paddock area;
- j) The proposed schedule.

### 2.1.4 ENTRIES

- a) Entries shall be submitted to the CASC-OR Registrar by completing the Registration Form available on-line at <http://casc.motorsportreg.com/>.
- b) When more than one driver is competing in the same car the "Driver Declaration" form shall be completed showing which driver will be in the car for each session.
- c) Any change to the drivers participating in a session from what was declared on the driver's declaration form shall be provided to the Clerk prior to the session in which the change is to take effect.
- d) CASC-OR will publish a driver declaration form which shall be used for this purpose.

### 2.1.5 OFFICIAL EVENT PROGRAM

Any program offered to the public by the organizers shall contain the following information:

- a) The words "Official Program" in prominent lettering and the CASC-OR emblem on the front cover;
- b) A conspicuous announcement: "Held under the CASC-OR General Competition Rules";
- c) The name of the organizer;
- d) Name, location and date of the Event;
- e) Schedule of proposed Competitions;
- f) The CASC-OR website address.

### 2.1.6 NUMBER OF ENTRIES TO BE STARTED IN RACES

- a) The maximum number of Cars, which may be on course at the same time, shall be 25 per mile, or proportion thereof.
- b) CASC-OR may authorize an increase in this number.

### 2.1.7 MINIMUM MEDICAL, FIRE AND RESCUE REQUIREMENTS

The following minimum requirements shall be in effect while a Competition is in progress:

- a) Medical, fire and rescue services as specified in Appendix F – Medical, Fire and Rescue, hereto;

- b) Fire equipment in the pits, false grid and impound area as specified in Appendix G – Rules of the Pits and Paddock, hereto;
- c) A written plan to cope with major emergencies;
- d) Driver Schools ONLY: The minimum requirements for these events are specified in Appendix A – Drivers Schools, hereto.

### 2.1.8 INSURANCE

CASC-OR is the holder of a Master Policy for Motorsport Competitions of which CASC-OR and its member clubs and organizers and promoters are named insured.

CASC-OR requires that Public Liability and Participant Accident Insurance cover all sanctioned Competitions. For all Competitions, minimum coverage shall be \$5,000,000 Spectator Liability, \$5,000,000 Participant Legal Liability, \$25,000 Accidental Death and Dismemberment, and \$100/wk. for 52 wk. Weekly Indemnity. Details of coverage required may be obtained from CASC-OR.

A copy of the insurance certificate shall be provided to the CASC-OR office no less than seven (7) days prior to any sanctioned event organized by a CASC-OR club.

## 2.2 CLASSIFICATION OF EVENTS

Events sanctioned by CASC-OR shall be classified according to the persons eligible to take part, the categories of Cars eligible to participate, and the awards offered.

### 2.2.1 CASC-OR EVENTS

CASC-OR may grant sanctions to organize various classes of Events – including Races and Driver Schools - to be conducted in accordance with these Regulations:

### 2.2.2 CLASS GROUPING OF CARS

- a) With the exception of Vintage Historic cars as noted in 2.2.2 b), Open- and Closed-wheel Cars may not compete together.
- b) Vintage Historic (pre-1972 era) Open- and Closed-wheel Cars may compete together providing the individual maximum weight of the Closed-wheel Car does not exceed 2500 lbs. An exemption to compete with Open-wheel cars may be granted, on an individual basis, for Closed-wheel Cars that weigh more than 2500 lbs., which do not meet the G70+ safety requirements, providing the maximum calculated energy developed does not exceed 2.11 million Joules. The formula for the calculation of energy shall be  $E = 0.5 \times M \times V^2$ , where M is the mass expressed in kilograms and V is maximum velocity in metres per second. Application for any exemption shall be made to the [VARAC Race Director](#).
- c) **All competitors on a grid of Vintage/Historic Cars shall adhere to the requirements of the VARAC Conduct Procedures, regardless of the age of their car. See the VARAC Conduct Procedures here: <https://varac.ca/carinfo/conduct-procedures>.**
- d) Sports Racing Cars shall normally run with an open wheel grid unless otherwise classified by the **Race Director or** Regional Chief Scrutineer.

## 2.3 GRIDDING AND STARTING

### 2.3.1 GRIDDING

- a) Gridding shall be by qualifying times or by the results of the previous heat Race. All qualifying laps shall be timed. Cars not timed in qualifying shall be placed at the back of the grid behind the slowest qualified car in the session in the order approved by the Clerk. The fastest car shall be on the pole position with subsequent slower cars behind it. It shall be the Car/Driver combination which qualifies for a starting position. In the case of a tie in qualifying times, the second fastest lap, then the third fastest lap, and so on will be used to break the tie.

If a back-up car is used, it shall start behind the last qualifier in the class. See Appendix P – Race Ontario Series Regulations, Section 5.3.

F1600 grids for the first race of an event shall be determined by qualifying times. Grids for the second race of an event will be determined by the fastest lap in race #1. Grids for the third race of an event will be determined by the fastest lap in race #2.

- b) Other methods of determining grid position may be approved by CASC-OR and shall be included in the Series or Supplementary Regulations.

The pole position shall be as follows:

- i. when the first turn after the start is to the right, the pole position shall be to the right;
  - ii. when the first turn after the start is to the left, the pole position shall be to the left.
- c) The pole position winner shall have the right to choose the outside pole position if they so desire. This request shall be made to the False Grid Marshal at least 5 minutes prior to Cars leaving the False Grid. Only the front row of the grid shall be affected by this choice, with all subsequent positions from 3rd back remaining unchanged.
  - d) False Grid shall display an indication of 3, 2, and 1 minutes before cars will be released from False Grid. 5- and 4-minute notification may also be displayed.
  - e) Cars arriving at the False Grid after the three-minute notification shall be gridded at the back of the grid or if the field has left, will be governed by 2.3.1f) below. When ordered by an official, Cars shall leave the False Grid and enter the Pits or Racetrack.
  - f) Cars unable to start when the field leaves the False Grid may be held at the starting line, at Pit Out, or dispatched on the pace lap to assume a position at the rear of the field, at the discretion of the Clerk. Cars held at the starting line or Pit Out shall be allowed to join at the rear of the field after the Starting Flag has been shown.
  - g) A driver who does not complete a timed lap in either practice or qualifying and who has never raced at the track where the event is being held must obtain permission from the Clerk before they may compete in a race.

- h) *Participants in VARAC grids (Vintage Historic, Classic or Formula Classic) must understand the driver conduction principles as they apply to Vintage racing, and must be either a member of VARAC or approved by the VARAC Race Director.***

### 2.3.2 STARTS

- a) There shall be two methods of starting:
  - i. A rolling start occurs when the Cars are moving at the moment the starting signal is given. To achieve a rolling start, the Cars may be led by a Pace Car until the starting signal is given. Rolling starts are the standard for all Races but CASC-OR may approve the use of a standing start on an individual Competition or Series basis.
  - ii. A standing start occurs when the Cars are stationary at the moment the starting signal is given.
- b) Drivers and Cars shall come under the order of the Starter at the time they leave the False Grid to enter the Course.
- c) To be considered a starter, a Car must enter the Track before the checkered flag is displayed.
- d) A false start has occurred when a Car under the Starter's orders improves its prescribed position before the start. In the case of a rolling start, this shall refer to moving out of line or passing prior to the start. In the case of a standing start this shall refer to moving forward prior to the start.

### 2.3.3 ROLLING START

- a) Cars may be held briefly on the grid or Racetrack as appropriate until ordered by the Starter to begin the pace lap. Races shall begin with a minimum of one pace lap. A Pace Car may be used to control the field. See Guidelines for Pace Car Starts, Section 2.4, below.
- b) On the pace lap the Car in pole position shall maintain a steady pace until the start flag is shown. Cars shall not move from their prescribed starting position, immediately behind the Car in front, before the start flag is shown. After the pace lap is underway, any vacant grid positions shall remain vacant.



- c) There shall be no overtaking during pace laps.
- d) During the pace lap the Starter shall remain motionless with the start flag hidden and no other flags visible. Upon determining that the approaching field is in satisfactory order the Starter shall suddenly and continuously wave the start flag. The Race shall be underway the instant the start flag is waved.
- e) If the approaching field is not in order and a further pace lap is required, the Starter shall make no flag movement and at the same time shall shake his/her head in a negative manner. This shall inform the Drivers of a "No Start" and to proceed on another pace lap.
- f) Should drivers lose their original grid position as a result of a "non-start" they shall be allowed to resume that position on the additional pace lap without incurring any penalty provided such resumption of position is completed in a safe manner as soon as reasonably possible.
- g) Additional pace laps resulting from a "non-start" shall be scored as Race laps and in the case of elapsed time Races the clock shall start when the lead Car crosses the start finish line at the end of the prescribed pace lap.
- h) Cars, which fall out of position on the pace lap, shall relinquish their position and shall join the Competition at the rear of the field.
- i) Split rolling starts may be used when a large speed differential or large differential in cornering ability exists between two classes in the same Race.

#### 2.3.4 STANDING START

- a) If a standing start is to be used, the procedure shall be described in Series or Supplementary Regulations and approved by CASC-OR.
- b) It is highly recommended that the standing start procedure and starting light system described in the current ASN Canada Regulations be used.

#### 2.3.5 STARTING LINE

- a) For a rolling start, the starting line shall be the line on the crossing of which the timing commences.
- b) For a standing start, the starting line shall be the line in relation to which the position of each Car is fixed prior to the start.

#### 2.3.6 RAIN RACE PROCEDURE

- a) If a Race is started in the dry and it starts to rain, the Clerk may stop the Race by displaying the Checkered Flag if more than half the number of laps / amount of time specified in the Supplementary Regulations has been run.
- b) If the Race has not reached the halfway point the Black Flag with "ALL" may be displayed. Drivers shall complete the current lap and return to the pits. After 15 minutes to allow a tire change, Cars may be restarted in single file behind the Pace Car for one lap in the order in which the Cars passed the start/finish line on the leader's last completed lap prior to the black flags being displayed.

#### 2.3.7 STOPPING A PRACTICE SESSION

To stop practice sessions a checkered flag may be shown at another location, specified in the Supplementary Regulations, in addition to the Start/Finish. Immediately upon receiving a checkered flag at these Stations, Competitors shall proceed directly to the Pits.

#### 2.3.8 STOPPING A COMPETITION

If it is necessary to stop a Competition, the procedures outlined in Appendix H – Flag and Light Signals and Rules of the Road, Section 3.3 shall be used.

#### 2.3.9 RESTARTS

The following procedure shall be followed to restart a Race after the display of the red flag:

- a) If the lead Car has completed less than two laps at the time the Red Flag is displayed, the original start shall be deemed null and void and the Competition shall be restarted according to

the original starting positions and be run the complete scheduled length unless the length of the race is shortened due to time or other constraints. If some of the original Cars are unable to start, the grid shall be adjusted with no vacant spaces. Cars may be worked on in the pits or on the grid. If work is carried out on the grid, this work shall be done in the car's correct grid position and shall in no way impede the restart.

- b) If the lead Car has completed two or more laps at the time the red flag is displayed, the Competition shall be re-gridded with the Cars in single file in the order in which the Cars passed the start/finish line on the leader's last completed lap prior to the red flag being displayed. No work or service may be performed on the cars unless otherwise permitted by the Supplementary Regulations or by the Clerk.

#### 2.3.10 SHORTENED RACES

- a) A Race that is stopped at 50 percent or more of its scheduled distance/time and is not re-started shall be considered complete and shall be scored as of the last completely scored lap (even if that lap is less than 50% of the scheduled distance).
- b) A Race that is stopped at less than 50 percent of its scheduled distance/time and is not re-started shall be considered incomplete. Championship points shall not be awarded, and organizers shall not be required to distribute trophies or other awards.

#### 2.3.11 DEAD HEATS

In case of a dead heat, the Competitors concerned shall share the awards allotted to their places in the results.

#### 2.3.12 FINISHING

- a) The Starter shall show a "Last Lap" signboard at the appropriate time.
- b) A Race shall end after the prescribed number of laps has been completed or the allocated time has elapsed, and the checkered flag has been shown.
- c) The Checkered Flag normally shall be displayed first to the winner as they complete the prescribed distance of the course, and then to the other finishers as they cross the finish line.
- d) The winner shall be the Competitor who covers the prescribed distance of the Competition in the least time, or the greatest distance within the prescribed time of the Competition, unless the Race is shortened, in which case the leader at that point who takes the Checkered Flag is the winner provided that the Race is completed.
- e) In timed duration Races if the winning Car is not running at the expiration of the time specified for completion, the Checkered Flag shall be displayed to the highest placing Car still running, i.e., the winner is not required to take the Checkered Flag.
- f) Should the Checkered Flag be shown early, the Race shall end at that point.
- g) Should the Checkered Flag be shown late, the leader at the prescribed number of laps, or the allocated time, shall be the winner, and the finishing order shall be taken from that lap.
- h) The finish line extends across the track to the pit wall and includes the Pit Lane.
- i) In order to be considered a finisher, a car shall complete that number of laps equal to 50% of the class winner's laps. The number of laps completed shall be rounded down to the nearest whole integer.
- j) A competitor has 5 minutes after the display of the checkered flag to complete their current lap on main motor power.**

#### 2.3.13 SERVICE VEHICLES

Immediately following completion of any session and including cool down laps, Service vehicles, Wreckers, or Flatbeds may proceed onto the track from Pit Out and/or Emergency Vehicle stations around the track to remove disabled race cars.

#### 2.3.14 TIMING AND SCORING

- a) For rolling starts, the timing and scoring shall commence when the leading Car crosses the control line.

- b) For a standing start, the timing and scoring shall commence at the starter's signal, or, if an automatic timing apparatus is used, at the moment it is operated.
- c) The completion of the first and subsequent laps shall be timed and scored when the car crosses the control line.
- d) All Race laps shall be timed.

#### 2.3.15 CROSSING A CONTROL LINE

A Car crosses a control line when any portion of the Car first intercepts the vertical plane of the control line, as observed by the Officials assigned to record the passage, who may be aided by suitable automatic or semi-automatic equipment. The control line extends across the Course to the pit wall and includes the pit lane.

#### 2.3.16 VICTORY LAPS

The Clerk may offer winning Drivers an opportunity to take a Victory Lap driven at non-racing speed with the Checkered Flag and may permit suitably equipped Cars to carry a passenger on the Victory Lap provided that the passenger is 18 years or older and has signed the insurance waiver. It is recommended that the passenger wear an approved helmet.

#### 2.3.17 RESULTS

The results shall be titled "Provisional Results" and shall include the following.

- a) The location of event, date, name and/or logo of organizing club, CASC-OR logo, length of course and name and/or logo of series sponsor.
- b) The total number of entries, including DNF's and DNS's, the overall and class finishing positions for all entrants, the number of laps completed by all entrants, the overall time of each entrant (for races only), each entrant's time interval ahead of the next entrant, the fastest lap time for each entrant and new course records.
- c) The driver's full name, hometown, state/province, club affiliation, car number, car make & model, and sponsor.

Finishing positions shall be determined according to the number of laps completed regardless of whether or not a Car is running at the end of the Race. Cars finishing a given number of laps shall be ranked in the order in which they completed that number of laps. Cars shall be ranked on their last fully completed lap.

When a car is disqualified, excluded, or withdrawn, the results shall list that car at the bottom of the finishing order, below the DNF's and above the DNS's.

Provisional results for each race and qualifying session shall be posted in the paddock within 30 minutes of that race or qualifying session. Copies shall be made available to be picked up by Entrants at the track.

- d) Results shall be marked as Official after all outstanding protests and penalties have been dealt with and all Appeals have concluded.
- e) The Official results should be sent to the Regional Chief Points Keeper as soon as possible after the event completes.

## 2.4 PACE/SAFETY CAR - GENERAL REQUIREMENTS

A suitable Pace/Safety Car and qualified staff to operate it shall be provided for each Event. Only working Officials shall be permitted in the Pace/Safety Car during a race or pace lap. The Pace/Safety Car shall have high intensity roof mounted flashing lights visible from both the front and rear, or carry a yellow flag, and shall have radio communication with Race Control.

Only the Clerk may order the dispatch of a Pace/Safety Car for safety reasons to slow down and close up the Cars. It shall remain on stand-by ready for dispatch at all times during Competition and may be used at any time to control the Cars if

- i. the Course is partially obstructed due to an accident; or

- ii. if it is necessary for the marshals to expose themselves to unusual danger, or other such condition that the Clerk feels warrants such a procedure.

2.4.1 It shall be referred to as the 'PACE CAR' for the start of the race and subsequently as the 'SAFETY CAR'.

## 2.5 GUIDELINES FOR PACE CAR STARTS

2.5.1 After the entire grid starts rolling behind the Pace Car, the Pace Car shall gradually speed up to approximately 80 – 100 km/h and shall try to maintain that speed unless otherwise directed by the Clerk to:

- Corner 7 Flagger's Station at Canadian Tire Motorsport Park;
- End of the back straight at Shannonville Motorsport Park;
- Corner 16 Flagger's Station at Calabogie Motorsports Park

At that point the Pace Car shall slow down to approximately 70 km/h and the cars shall form into the proper starting lineup. Cars shall not continue to weave.

2.5.2 At Canadian Tire Motorsport Park, the Pace Car shall reduce speed to approximately 60 km/h entering corner 9 and shall enter the pit entrance between Corners 9 and 10.

2.5.3 At Shannonville Motorsport Park, the Pace Car shall reduce speed to approximately 60 km/h entering Corner 13 and shall enter the pit entrance between Corners 13 and 14.

2.5.4 At Calabogie Motorsports Park, the Pace Car shall reduce speed to approximately 60 km/h entering Turn 17 and shall enter the pit entrance between Corners 18 + 19.

2.5.5 During the starting procedure the Pace Car shall not be passed on the track or entering the pit lane.

2.5.6 The front row of the grid shall continue at the speed set by the Pace Car until the starting signal is given.

## 2.6 RESTART PROCEDURE

2.6.1 When the Safety Car is used during Competition, the following procedure shall be followed:

- a) The Clerk shall order the display of double steady yellow flags at all marshal stations around the course (*i.e., full course yellow*).
- b) Appropriate flags shall be waved at the stations preceding the incident.
- c) When the yellow flags are displayed at all marshaling stations, the Safety Car may be dispatched.
- d) The Safety Car shall turn on the lights or display a yellow flag and endeavour to enter the Course directly in front of the lead Car. Should it fail to do so, and when so instructed by Race Control, the other Cars shall be waved past until the lead Car is directly behind the Safety Car. The other Cars shall carefully close up until they are running in single file behind the Race leader.
- e) Unless directed to do so by Officials in the Safety Car, no Car may pass the Safety Car.
- f) When a service vehicle is dispatched while the Safety Car is in use, the white flag shall be used in the normal way in addition to the yellow flags. In normal practice the white flag will not be used to indicate the presence of the Safety Car on the Course. However, it may be waved to indicate the back of the pack as an advisory to approaching race cars.
- g) Prior to a restart, the Safety Car shall extinguish the flashing lights, or withdraw the yellow flag, at least three (3) flag stations before the Start/Finish line, and at the same time, one (1) yellow flag shall be withdrawn at all marshal stations. The Safety Car shall exit to the pits upon reaching the pit entrance and the marshals shall withdraw their remaining yellow flag when the Starter shows the green flag.
- h) The Starter will show the green flag provided the field is in good order. *Racing resumes at the display of the green.* If the starter does not show the green flag, the field will continue in single file behind the Race leader.

## **2.7 SCORING OF PACED LAPS**

All laps under the control of the Pace/Safety Car shall be counted as Race laps.

## **3 ENTRANTS AND DRIVERS**

### **3.1 CASC-OR RACE LICENCES**

3.1.1 CASC-OR shall establish standards for granting CASC-OR Race Licences, including:

- a) CASC-OR Probationary Race Licence;
- b) CASC-OR Regional Race Licence;
- c) CASC-OR Temporary Race Licence.

3.1.2 Procedures for application for and granting these licences are contained in Appendix E – Licences, hereto.

3.1.3 DISPLAY OF CASC-OR LOGO ON COMPETING VEHICLES

All vehicles competing in a CASC-OR sanctioned event shall display a CASC-OR logo in a position clearly visible in a front three-quarter view of the vehicle. Additional logos and/or positions may be required by subsequent rules and regulations.

### **3.2 PRESENTATION OF LICENCE**

Drivers shall show their licence to an Official on demand.

### **3.3 PREFERRED NAMES**

3.3.1 If a licence is requested in a preferred name, special application therefore shall be made to CASC-OR, which may if it sees fit, issue a licence in such name.

3.3.2 Persons granted a licence in an assumed name shall, so long as they hold a licence in that name, not take part in any Competition except under the name shown on such licence.

### **3.4 MEDICAL RESPONSIBILITY OF DRIVER**

3.4.1 Drivers shall not compete in any Competition unless a physician has examined them within the period specified in Appendix E – Licences, hereto, and has been certified by the physician in writing to be medically fit to drive in Car Competition.

3.4.2 A licence holder who suffers an injury or is diagnosed with an illness that may reasonably have the potential to affect, or may progress to affect, his or her medical fitness to drive in Competition shall report the illness or injury to the CASC-OR Chief Medical Officer (CMO). In the absence of the CMO, the report shall be made to the CASC-OR Race Director exclusive of the specific detailed medical information. The Race Director shall, in consultation with the CASC-OR Board, arrange for a consultation with a CMO Designate to make the determination of medical fitness or a referral for a fitness assessment from a medical specialist who is acceptable to both the license holder and the CMO before competing in further competition. The CMO/CMO Designate/Race Director may require a medical certification of fitness to compete or a medical assessment.

3.4.3 A Driver involved in an incident in which their vehicle rolls over, collides with a stationary object hard enough to cause structural damage to the Car, or causes possible physical injury to the Driver, or who is directed by an Official to do so, shall report to the Chief Medical Officer at the event.

3.4.3.1 The Driver involved in the incident will require the Chief Medical Officer's (CMO) approval in writing to the Clerk before being permitted to re-join the competition.

- 3.4.4 A Driver who fails to report to the Chief Medical Officer at the Event in accordance with 3.4.3 above, may have his or her licence suspended by the Race Director until such time as they are determined to be medically fit to drive in Competition by the CASC-OR Chief Medical Officer, as set out in 3.4.2 above.

## **4 OFFICIALS**

### **4.1 CHIEF OFFICIALS**

- 4.1.1 The staff of Chief Officials, whose duty it may be to direct the control of the Event may include:

- a) Steward(s) of the Event
- b) Clerk of the Course
- c) Event Chief Medical Officer
- d) Emergency Services Officer
- e) Secretary of the Meeting
- f) Chief Timekeeper
- g) Chief Scrutineer
- h) Chief Pit Lane Official
- i) Chief Starter
- j) Judges of Fact
- k) Chief Course Marshal
- l) Chief Grid Marshal
- m) Chief Registrar
- n) Event Chief Instructor

- 4.1.2 They shall be termed "Officials" and may have assistants to whom any of their duties may be delegated. Chief Officials shall be at least eighteen (18) years of age.

- 4.1.3 Clerks, Assistant Clerks, Stewards of the Event, Scrutineers, Pit Lane Officials and Marshals shall hold CASC-OR licences as outlined in Appendix E – Licences, of these Rules and Regulations.

### **4.2 REQUIRED OFFICIALS**

#### **4.2.1 REQUIRED OFFICIALS**

- a) At an Event, other than Driver Schools, there shall be at least three Stewards of the Event, a Clerk, a Scrutineer, a Timekeeper a Judge(s) of Fact and an Event Chief Instructor. CASC-OR may, at their discretion, increase or reduce the number of Stewards required.
- b) At a Driver School, there shall be an Event Chief Instructor.

#### **4.2.2 APPOINTMENT OF OFFICIALS**

The Stewards of the Event shall be appointed by CASC-OR. The organizers, subject to the approval of CASC-OR, shall appoint all other Officials.

#### **4.2.3 PLURALITY OF DUTIES**

The same person may hold more than one Official position except for the Clerk and the Stewards of the Event who shall have no plurality of duties.

### **4.3 DUTIES OF THE CLERK OF THE COURSE**

- 4.3.1 The Clerk of the Course shall be present throughout the competition in order to carry out the specified duties. In the case of an event comprising several competitions there may be a different Clerk for each competition.

They shall hold a Clerk's licence issued by CASC-OR and valid for that grade of event (see Appendix E – Licences, hereto) and is responsible for executing the event and other activities safely and in accordance with the regulations, by controlling drivers, their cars, the officials, and workers from the commencement of activities until the time for protests from the last competition has expired. The Clerk shall also:

- a) ensure that all relevant regulations are complied with and that all the equipment needed to do so is at hand or in use as appropriate;
- b) ascertain whether Officials are at their posts, and report the absence of any of them to the Stewards of the Event;
- c) ensure that all Officials are provided with necessary information;
- d) prevent an ineligible Driver or Car from competing;
- e) ensure that a Competitor unable to produce any document necessary to prove his/her eligibility at an Event does not compete without the approval of the Stewards of the Event;
- f) ensure that accidents or incidents involving competing vehicles are reported to the Stewards of the Event and the Chief Scrutineer, and that the Chief Medical Officer is informed if any Competitor is injured;
- g) report to the Stewards of the Event before the start of the Event that the conditions of the permit and Course licence (where appropriate) have been fulfilled after the Clerk, or an appointed deputy, has inspected the Course and its installations;
- h) convey to the Stewards of the Event any proposal to modify the schedule of Competitions;
- i) receive protests from Entrants or Drivers and immediately transmit them to the Stewards of the Event;
- j) collect all reports and other official information necessary for the determination of results;
- k) prepare, or arrange with the Secretary of the Meeting to prepare, any information necessary to enable the Stewards of the Event to complete their report;
- l) convey to the Stewards of the Event a report of any breach of the Regulations or of any misbehavior of any Entrant, Driver, Crew, Official, or worker accompanied by a "Request for Action", if necessary;
- m) may assess the recommended minimum penalties defined in Appendix B – Fees and Minimum Penalties, Sections 2.4, 2.5 and 2.7 and in Appendix Q – Endurance Race Regulations, Section 11 for breaches of these regulations reported by a Judge of Fact. The penalty shall be Black Flag - Stop and Go unless otherwise specified. A written report, including any documentation, of these penalties shall be filed with the Stewards of the Event.
- n) make arrangements in conjunction with the Chief Medical Officer for medical checks to be carried out in respect of narcotics, dangerous drugs or alcohol;
- o) authorize removal of technical inspection stickers;
- p) direct Cars to be impounded at any time during the Event;
- q) at his/her discretion and without necessarily receiving a request to do so, order disassembly and inspection of any entered Car to ascertain its conformance with the Regulations;
- r) order the display of the Red or Black Flag when it is necessary to stop a Competition.

#### 4.3.2 REQUEST FOR ACTION (RFA)

The Clerk may submit to the Stewards of the Event a "Request for Action" describing a suspected breach of the Regulations or of misbehavior by any Participant. The Stewards of the Event shall act on this request in the same manner as they would act on protest and shall have the same authority to levy penalties as in protest.

## 4.4 DUTIES OF THE SECRETARY OF THE MEETING

- 4.4.1 The Secretary of the Meeting shall be responsible for the organization of the Event as regards all planning required in connection therewith:



- a) the Secretary shall ensure that the Officials are acquainted with their duties and are provided with the necessary equipment;
- b) the Secretary shall be present throughout the Competition in order to assist the Clerk and the other Officials in running the Event;
- c) the Secretary shall be responsible for all paperwork prior to the Event;
- d) the Secretary shall maintain the official notice board;
- e) prior to the commencement of an event, the Secretary shall be responsible for supplying the Clerk with the Event Permit and Insurance and the Stewards of the Event with all appropriate documents including a copy of the Supplementary Regulations.

#### **4.5 DUTIES OF THE CHIEF TIMEKEEPER**

4.5.1 The Chief Timekeeper shall be responsible for all timekeeping and lap scoring for the Competition.

The principal duties shall be:

- a) to use only such apparatus for timing as is approved by CASC-OR;
- b) to register such times as are appropriate having regard to the conditions of the Competition, or as required by the Clerk;
- c) to prepare and sign reports relating to the timing and lap scoring and to send them, with all necessary supporting documents to the Clerk;
- d) to send an electronic copy of the results of all sessions to the CASC-OR office by noon the day following the competition and, upon request, to send any and all timing or scoring supporting information to the CASC-OR office;
- e) to communicate any times or results only to the Stewards of the Event and the Clerk - or in accordance with their instructions;
- f) The Chief Timekeeper shall be the Judge of Fact in respect of timing and lap scoring matters.

#### **4.6 DUTIES OF THE CHIEF SCRUTINEER**

4.6.1 The Chief Scrutineer shall:

- a) ascertain that all Cars comply with the Regulations and that Driver Safety Equipment complies with the Regulations.
- b) when a Car is found to be ineligible, report the results of the weighing, inspection and disassembly, in writing, only to the Clerk and the Driver, or the designated representative of the Driver.
- c) report in writing to the Clerk any items of Driver Safety Equipment which do not comply with the Regulations.

#### **4.7 DUTIES OF THE CHIEF PIT LANE OFFICIAL**

4.7.1 The Chief Pit Lane Official shall ensure that pit procedures as laid down in the Regulations are adhered to, and shall specifically:

- a) observe all refueling and/or repairs of Cars during a Competition;
- b) ensure that the maximum number of Crewmembers specified in the Regulations is not exceeded;
- c) immediately report to the Clerk any infringement committed by a Competitor;
- d) enforce all Pit regulations as specified in Appendices "G" – Rules of the Pits and Paddock, and "Q" – Endurance Race Regulations;
- e) set up and control pit speed measuring devices;
- f) The Pit Lane Officials shall be the Judges of Fact in respect of Pit Lane rule violations.



## **4.8 DUTIES OF THE CHIEF STARTER**

- 4.8.1 The Starter shall operate directly under the supervision of the Clerk.
- 4.8.2 All competing Drivers shall be under the orders of the Starter from the time the Cars leave the False Grid to enter the course until the session is completed.
- 4.8.3 The starter shall start the Competition with the starting flag and end the Competition by displaying a Last Lap sign and then the checkered flag.
- 4.8.4 The Starter shall display various other flags and signs when instructed to do so by the Clerk. In the event of inclement weather and under instruction from the Clerk, the Starter shall display a "Lights On" sign and/or to display various other flags.
- 4.8.5 The numbers and letters used by Starters shall meet these standards:
  - a) They shall be no less than 200mm (8in) high with a 38mm (1 1/2in) stroke;
  - b) The distance between them shall be no less than the stroke of the digits or letters;
  - c) They shall be shown on a contrasting background measuring 60cm x 80 cm minimum.

## **4.9 DUTIES OF THE CHIEF MEDICAL OFFICER**

- 4.9.1 The Chief Medical Officer shall be a Physician and shall:
  - a) Ensure that they - or the second Physician, Registered Nurse, EMT, Paramedic or equivalent – is always on call in Race Medical.
  - b) Review the Event Emergency Plan and meet with the Emergency Services Officer.
  - c) be familiar with the Coroner's Act of the Province.

## **4.10 DUTIES OF THE JUDGES OF FACT**

- 4.10.1 Judges shall report on violation of Pit Lane rules; blend line infractions; and any other facts to be judged as specified in the Supplementary Regulations.
- 4.10.2 A protest or appeal may not be made against the decision of a Judge, which shall be accepted as a fact and shall be final unless corrected as hereinafter provided.
- 4.10.3 The decision shall not constitute a statement of results, nor shall the Judge be empowered to impose a penalty.
- 4.10.4 Judges will report to the Clerk for the necessary action to be taken.
- 4.10.5 The Judge, with the approval of the Stewards of the Event, may correct a mistake by a Judge.
- 4.10.6 An Assistant Judge may be appointed to assist a Judge, or in the case of absolute necessity, to replace the primary Judge of Fact. In the Event of disagreement, the Judge shall give the decision.
- 4.10.7 In all cases where a penalty has been imposed as the result of a decision of a Judge, an appellant against the penalty shall be allowed full disclosure of all written or other evidence available.

## **4.11 DUTIES OF OBSERVERS**

- 4.11.1 The Observers shall occupy posts along the Course assigned to them. Observers are under the orders of the Clerk, to whom they shall report by any means at their disposal (telephone, radio, courier, etc.) all incidents which occur on the section of the Course for which they are responsible.
- 4.11.2 Course Marshals may also act as Observers.

## **4.12 DUTIES OF THE CHIEF GRID MARSHAL**

The Chief Grid Marshal shall be responsible for placing Cars in their grid positions on the False Grid and/or real grid. The Chief Grid Marshal shall ensure that all Cars entering the Track bear the scrutineering sticker indicating that they have entered and been scrutineered, and shall control entry to the Track at all times.

## **4.13 DUTIES OF THE CHIEF REGISTRAR**

The Chief Registrar shall be responsible for checking, accepting and processing all entries and credentials for Drivers, crew, Officials, and all Participants, and for posting all required signs/placards in the registration area.

#### **4.14 DUTIES OF THE CHIEF COURSE MARSHAL**

- a) The Chief Course Marshal shall ensure that all corners are properly manned and equipped.
- b) The Chief Course Marshall shall convey any information deemed necessary to Race Control.
- c) The Chief Course Marshal shall ensure that copies of the telephone log are given to the Clerk.
- d) The Chief Course Marshal shall appoint senior marshals - who shall have documented records of experience – to each marshal Station and they shall be in complete charge of stations.

#### **4.15 DUTIES OF THE EVENT CHIEF INSTRUCTOR**

The Event Chief Instructor will fulfill all those duties described in Appendix E – Licences, Section 3.4 and/or as designated by the Regional Chief Race Coach / Instructor or CASC-OR Race Director.

#### **4.16 DUTIES OF THE EMERGENCY SERVICES OFFICER**

The Emergency Services Officer shall:

- a) Ensure that all medical and emergency services facilities and vehicles are adequately equipped and staffed in accordance with Appendix F – Medical, Fire and Rescue, hereto and the Event Emergency Plan.
- b) Ensure that all medical and emergency services staff are familiar with all requirements of the Event Emergency Plan.
- c) Review the Event Emergency Plan with the Chief Medical Officer.
- d) Obtain the approval of the Clerk for the locations of all emergency vehicles.
- e) Brief the crew of the Road Ambulance on relevant sections of the Event Emergency Plan and procedures on how to enter and exit the track.
- f) Ensure that Race Medical is open and operational.
- g) Report to the Clerk, when satisfied that all medical and emergency services are adequate for Competition to begin.

## APPENDIX A – RACE SCHOOLS

### 1 GENERAL PROVISIONS FOR RACE SCHOOLS

#### 1.1 ORGANIZATION OF RACE SCHOOLS

CASC-OR member clubs may organize Race Schools, which will result in the provision of a recommendation letter for the recognition of the on-track portion of a CASC-OR competition licence. Professional Race Schools may organize schools which will result in the provision of a recommendation letter for the recognition of both the on-track portion and the CASC-OR approved race procedures exam to satisfy the requirements for a CASC-OR competition licence. This section is a guide to the requirements and organization of such schools. These are minimum requirements only.

#### 1.2 STUDENT REQUIREMENTS

1.2.1 In order to be eligible to participate in a race school which leads to a CASC-OR competition licence, each prospective student shall:

- a) Be an affiliated member of a CASC-OR member club.
- b) Hold a valid provincial or state driver's licence.
- c) Have passed the specified CASC-OR medical examination for a first-time applicant.
- d) Applicants who are 15 years old shall meet the following requirements:
  - Have achieved their fifteenth birthday - no exceptions.
  - Produce a valid karting licence issued by ASN Canada or an ASN-affiliated kart club.
  - Proof of competing in at least two full seasons of ASN-sanctioned kart racing.
  - Have successfully completed an ASN or CASC-OR approved Race school.

### 2 COURSE ORGANIZATION

#### 2.1 REGIONAL CHIEF RACE COACH / INSTRUCTOR

2.1.1 The Race Director shall appoint a Regional Chief Race Coach / Instructor.

2.1.2 The Regional Chief Race Coach / Instructor shall report to the Race Director.

#### 2.2 THE DUTIES OF THE REGIONAL CHIEF RACE COACH / INSTRUCTOR

2.2.1 The duties of the Regional Chief Race Coach / Instructor include:

- a) organize CASC-OR race schools;
- b) approve and monitor driving schools organized by CASC-OR member clubs;
- c) approve and monitor professional racing schools;
- d) organize training of Coach / Instructors;
- e) organize and approve licensing of Coach / Instructors;
- f) evaluate performance of drivers seeking re-instatement of their competition licence or an upgrade of an existing Competition Licence;
- g) arrange mentoring for novice drivers;

- h) on request from clerk/stewards arrange further observation of a driver;

## **2.3 COACH / INSTRUCTORS**

- 2.3.1 Coach / Instructors shall hold a current CASC-OR Coach / Instructor's licence.
- 2.3.2 The names and addresses of the trained and approved Coach / instructors will be submitted to CASC-OR by the Regional Chief Race Coach / Instructor requesting the issue of Coach / Instructor licences.
- 2.3.3 The Coach / Instructors shall mentor, coach, and observe drivers as assigned by the Chief Race Coach / Instructor.

## **2.4 PERMIT REQUIREMENTS**

Each club operating a racing school shall obtain an annual permit from the CASC-OR Race Director and/or the CASC-OR Chief Race Coach / Instructor to operate such racing school. The permit shall be prominently displayed at the school. Professional racing schools, as referenced in Section 4, shall obtain annual written approval of the CASC-OR Chief Race Coach/Instructor.

## **2.5 PRACTICAL INSTRUCTION**

The practical instruction of the students on the course shall be carried out simulating actual Competition conditions in Cars fitted with seat belts and with Drivers and Instructors wearing helmets meeting the current CASC-OR standards.

Cars with permanently fixed steel roofs but without roll cages will be permitted to enter the instructional portion of the school but are not permitted to participate in any form of wheel-to-wheel Competition, even if that Competition is included as part of the school.

## **2.6 COMPETITION LICENCE APPLICATION FOR GRADUATES**

Students who have successfully completed a club-operated race school may apply for on-track portion of a CASC-OR competition licence. Students will then need to complete the CASC-OR approved race procedures exam to satisfy the requirements for a CASC-OR competition licence. This exam is currently being offered by some Professional Race Schools. The application for a CASC-OR competition licence shall be made within twelve months of completing either of the aforementioned schools.

## **3 REQUIRED SERVICES**

- a) 1 ambulance with paramedic(s)
- b) 1 track services vehicle with brooms, speedy dry and spreader
- c) enough marshals to man stations giving line-of-sight around the track
- d) manned stations to be equipped with at least one 10lb fire extinguisher, a communication system in contact with control and a set of flags

## **4 PROFESSIONALLY ORGANIZED DRIVER SCHOOLS**

### **4.1 APPROVAL OF PROFESSIONALLY ORGANIZED SCHOOLS**

In addition to schools organized by CASC-OR and clubs, the Regional Chief Race Coach / Instructor may approve certain professionally organized race schools. Such approval will be based on the following;

- a) a review of the schools current ASN Canada license;
- b) a review of the curriculum of the school;
- c) a review of the qualifications of the instructors at the school;
- d) a review of the exam based on the CASC-OR Race Regulations.

Successful completion of the course at such approved race schools will qualify the student for a regional Driver

'B' licence.

#### **4.2 AVAILABILITY OF PROFESSIONAL SCHOOL INFORMATION**

A list of currently approved professional schools is available from CASC-OR.

#### **4.3 APPLICATION FOR PROFESSIONAL SCHOOL APPROVAL**

Application for approval of a school shall be made in writing to the Regional Chief Race Coach / Instructor.

DRAFT

## APPENDIX B – FEES AND MINIMUM PENALTIES

### 1 FEES

#### 1.1 PROTEST FEE

- a) The fee required to place a Protest is \$100.00.
- b) The fee shall only be returned if the protest is deemed well founded or if so directed by the Stewards of the Event.

#### 1.2 APPEAL FEE

- a) The fee required to place an Appeal is \$200.00.
- b) The fee shall only be returned if the appeal is deemed well founded or if so directed by the Appeal Board.

#### 1.3 SANCTION AND PERMIT FEES

For Sanction and Permit fees contact CASC-OR Office.

### 2 RECOMMENDED MINIMUM PENALTIES

More severe penalties than those listed herein may be assessed. Multiple/repeat offences may incur additional penalties. If the first and second offences occur in separate sessions on the same weekend, penalties shall be imposed as if three (3) offences had occurred. Listed penalties should normally be applied on a finding of rule contravention. Mitigated sanctions may be applied at the discretion of the hearing tribunal.

#### 2.1 PASSING IN A YELLOW ZONE

##### 2.1.1 DURING PRACTICE

- a) Upon first offence, the offending driver shall be placed behind the last qualified car in class for the next race.
- b) Upon second offence, the offending driver shall be excluded from the next qualifying session. If all qualifying has already occurred, the driver shall start from pit out, last in line to depart.
- c) Upon third offence, the offending driver shall be excluded from the event, and recommendation shall be made to CASC-OR to suspend competition privileges for at least 3 months.

##### 2.1.2 DURING QUALIFYING

- a) Upon first offence, the offending driver shall be placed behind the last qualified car in the class.
- b) Upon second offence, the offending driver shall start their race from the pit lane last in line to depart.
- c) Upon third offence, the offending driver shall be excluded from the event and recommendation shall be made to CASC-OR to suspend competition privileges for at least 3 months.

##### 2.1.3 DURING A RACE

- a) Upon first offence, the offending driver shall be moved to last finisher in the class.
- b) Upon second offence, the offending driver shall be excluded from the results.
- c) Upon third offence, the offending driver shall be excluded from the event and recommendation will be made to CASC-OR to suspend competition privileges for 3 months.

## 2.2 ILLEGAL SAFETY EQUIPMENT (CLOTHING)

- a) Upon first offence, a \$100 fine will be assessed for each and every item not meeting the regulations. The offending driver shall produce correct apparel to the Scrutineer before being allowed to compete again.
- b) Upon a second offence at the same event, the driver may be excluded from the event.

## 2.3 UNDERWEIGHT CARS

Cars found to be underweight shall be excluded from the results.

## 2.4 VIOLATION OF THE PIT OUT BLEND LINE

### 2.4.1 DURING PRACTICE

- a) Upon first offence, the offending driver shall lose their fastest qualifying time.
- b) Upon second offence, qualifying times set by the offending Driver will be excluded.

### 2.4.2 DURING QUALIFYING

- a) Upon first offence, the offending driver shall be placed behind the last qualified car in the class.
- b) Upon second offence, the offending driver shall start the race from the pit lane, last in line to depart.

### 2.4.3 DURING A RACE

The offending driver will be assessed a 1-minute penalty added to his or her overall race time, or brought into the Pits to serve a 30 second penalty for each offence. **See also Appendix G, Section 1.13.3.**

## 2.5 VIOLATION OF THE PIT LANE SPEED LIMIT

### 2.5.1 DURING PRACTICE AND QUALIFYING

- a) Upon first offence, the offending driver will be moved one class position lower on the race grid.
- b) Upon second offence, the offending driver will be moved two class positions lower on the race grid.
- c) Upon third offence, the offending driver will be excluded from the event and a recommendation will be made to CASC-OR to suspend competition privileges for 3 months.

### 2.5.2 DURING A RACE

- a) Upon first offence, the offending driver shall be moved one class finishing position lower in the results. In endurance-type races the driver may be brought into the pits to serve a penalty equal in time to one second per km/h over the limit. (e.g., 78km/h = 18 seconds stop penalty)
- b) Upon second offence, the offending driver shall be moved two (2) class finishing positions lower in the results.

Upon third offence, the offending driver will be excluded from the event and a recommendation will be made to CASC-OR to suspend competition privileges for 3 months.

## 2.6 FAILURE TO OBEY A BLACK FLAG

Drivers who ignore a black flag shown with the Car number for more than 1 lap may be excluded from the results of the Competition.

## 2.7 TAKE TWO CHECKERED OR RED FLAGS

### 2.7.1 DURING PRACTICE AND QUALIFYING

*A competitor who takes two checkered flags or failed to stop in pit lane under red flag conditions will be moved one class position lower on the race grid.*

**2.7.2 DURING A RACE**

*A competitor who takes two checkered flags or failed to stop appropriately under red flag conditions will be moved one class position lower on the final results.*

**2.8 FAILURE TO OBEY OFFICIALS**

*A competitor who refuses to obey the order of a designated official may be penalized up to exclusion from the results of the Competition.*

**2.9 JUMP OR FALSE START**

Drivers who gain an advantage at the start of the race and before the display of the Green Flag shall receive a penalty of 2 positions in class.

**2.10 REFUSING TO DISASSEMBLE**

Failure to comply with an order for mechanical disassembly shall result in exclusion from the Competition or the Event, and any additional penalties deemed appropriate by the Stewards of the Event.

**2.11 TOW HOOK / STRAP**

Failure to provide a working tow hook / tow strap, or should the existing tow hook / strap fail may result in an assessed fine of up to \$500.

DRAFT



## APPENDIX C - GLOSSARY

**Accessible:** Capable of being reached.

**Airfoil:** Any device or part of a Car, which has a principle effect of creating aerodynamic down force.

**ASN Canada:** Refers to the national ASN, meaning Sports Development Group / Groupe de Développement Sportif.

**Associate:** To join or connect together.

**Bodywork:** All parts of the Car licked by the air stream and situated above a plane passing through the center of the wheel hubs with the exception of the roll cage. For Formula and Sports Racing Cars further exceptions are those units definitely associated with the function of the engine or transmission.

**Drive shaft:** The mechanical drive train coupling between transmission and differential, which may allow an angular displacement of the driving and driven axes by the use of universal, constant velocity, flex or slide joints.

**Duct:** A pipe, tube or channel that conveys a substance.

**Enclose:** To close in, to surround.

**Fairing:** A member or structure whose primary function is to produce a smooth outline to reduce drag or air resistance.

**Firewall:** A metal bulkhead separating Driver's compartment from engine room preventing the passage of flame and debris. Metal ducts may penetrate the firewall but shall begin and end outside the Driver's compartment. No intakes are allowed in the firewall.

**Force Majeure:** *An event or effect that cannot be reasonably anticipated or controlled.*

**Intake:** An opening through which fluid/air enters an enclosure.

**Lubricant:** A substance which can be interposed between moving parts of machinery to make surfaces slippery, reduce friction, and prevent sticking between the lubricated surfaces.

**Metallic:** Made of metal.

**Outline:** A line that marks the outer limits of an object or figure.

**Production Car:** A car which meets the North American Global Manufacturing standards.

**Restrictive:** Serving or tending to restrict or regulate.

**Specification:** A detailed precise presentation of something.

**Surround:** To enclose on all sides.

**Suspension:**

- a) **MacPherson/Champion Strut:** MacPherson/Champion Strut suspension consists of three pivoting attachment points including a single upper attachment point. The spindle is mounted on a telescoping post with no vertical movement at the top attachment point.
- b) **Trailing Arm:** Pivot points are forward of the axle centerline and are perpendicular to the longitudinal centerline.
- c) **Semi-Trailing Arm:** Pivot points are forward of the axle centerline with the forward pivot closer to the axle centerline than the outboard pivot.
- d) **Suspension Components:** Linkage connecting spindles, hub carriers or axles to the chassis allowing control of vertical movement and may carry longitudinal, lateral, and vertical loads.

**Suspension Stabilizer:** Linkage connecting axle or DeDion tube to the chassis, which controls lateral suspension location. (Some types of stabilizers may also serve as Suspension Components.)

**Anti-roll Bar or Anti-sway Bar (ARB):** A torsion bar or tube linked between the suspension and the chassis to control the chassis roll. (Some types of ARB may also serve as suspension component.)

**Venturi:** (Carburetor) A short tube or permanent part that is constricted in the center used for measuring airflow and thereby controlling fuel functions. It is not a jet.

**Visible:** Capability of being seen, perceptible to the eye, apparent, evident.

**Wheel:** Flange and rim.

**Wheel Complete:** Flange, rim, and tire.

**Vehicle Track:** Track is defined as the distance between the center-lines of the tire treads as raced, but without Driver, measured at a horizontal plane through the wheel hub center-line. (In practice, the average between the tread center-lines at the front and rear of the tires on the axle in question.)

DRAFT

## APPENDIX D – PROTESTS AND APPEALS

"THE SPECIFIC PROCEDURE FOR LODGING A PROTEST OR APPEAL IS DEFINED IN THE CASC-OR GENERAL COMPETITION REGULATIONS."

### 1 PROTESTS AGAINST RACE OFFICIALS

A notice of intention to protest against a Race Official shall be lodged within twenty (20) minutes after completion of the Competition or notification of the Official's action or as agreed upon by the Protestor and the Stewards of the Event.

### 2 PROCEDURAL PROTESTS

A notice of intention to protest against any mistake or irregularity occurring while a Competition is taking place or on a matter that only becomes evident during the Competition shall be lodged within twenty (20) minutes after the finish time of the Competition, or within such further time as the Stewards of the Event may deem reasonable. The protest shall be lodged within a time limit agreed upon by the protestor and the Stewards of the Event and shall be subject to scheduling constraints. This time limit shall be not less than forty-five (45) minutes.

### 3 PROTEST OF RESULTS

A protest concerning a Competitor's results in an Event, or the make-up of heats, shall be made within thirty minutes of posting, in a manner previously designated by the organizer, of that Competitor's results or the make-up of heats, or within such further time as the Supplementary Regulations may allow, or such time as the Stewards of the Event may think justifiable in order to make the lodging of a protest physically possible.

### 4 TIME LIMITS

If the results of a Competition are not posted within thirty minutes of the completion of the final Competition of the first day of a two-day Event, then a Competitor of that competition may lodge a protest on the following day up to thirty minutes before the start of their next Competition.

### 5 PUBLICATION OF RESULTS

If results are not made available within one (1) hour of the conclusion of the Event then the protest shall be delivered to the CASC-OR office in person, by mail, courier, telegram or facsimile or other electronic means within seven (7) days of the postmarked date of the mailing of results to all Competitors.

## APPENDIX E - LICENCES

### 1 RACE DRIVER LICENCES

#### 1.1 PRESENTATION OF LICENCES

It is the Competitor's responsibility to present a valid Race licence at registration.

#### 1.2 RESIDENCY REQUIREMENTS

Residents of Canada shall have a CASC-OR, an ASN Canada, or other ASN Canada-authorized Territorial Race licence to compete in a CASC-OR sanctioned Event subject to Section 1.4 below.

Only members of a CASC-OR affiliated club may accumulate points towards a CASC-OR championship.

Members of CASC-OR clubs that may hold other accredited licences, (e.g., SCCA, IMSA, INDYCAR, USAC/PWC, USAC, PWC, RCNA), may also accumulate points with prior approval from the CASC-OR Race Director or Chief Race Coach / Instructor.

#### 1.3 ACCUS RACE LICENCES

Race licences issued to residents of the USA by one of the following ACCUS sanctioning organizations will be honored at the same level as issued: SCCA, IMSA and IRL.

#### 1.4 RACE LICENCES FROM OTHER SANCTIONING BODIES

A Competitor who holds a Race licence issued by another recognized racing association including Porsche Club of America and a BMWCCA licence, but not SCCA, may participate as a guest in a CASC-OR sanctioned Event by invitation and with the prior approval of the CASC-OR Race Director. Guests may not accumulate points towards a CASC-OR Championship.

#### 1.5 PARENTAL PERMISSION

Applicants under the legal age of majority in their home province shall present permission from a parent or guardian on the prescribed form available from the CASC-OR office. The form shall be signed and witnessed.

#### 1.6 MINIMUM AGE REQUIREMENTS

Applicants for a CASC-OR competition licence must meet one of the following:

- 1.6.1 Applicants for their first CASC-OR Race licence shall be 16 years old or older and possess a valid provincial or state driving licence or meet the criteria of 1.6.2.
- 1.6.2 Applicants who are 15 years old shall meet the following requirements:
  - Have achieved their fifteenth birthday - no exceptions.
  - Produce a valid karting licence issued by ASN Canada or an ASN-affiliated kart club.
  - Proof of competing in at least two full seasons of ASN-sanctioned kart racing.
  - Have successfully completed an ASN-recognized Race driving school.
  - Have passed the normal ASN medical examination for a first-time applicant.

If successful, applicants may be issued a Driver 'B' Race Licence which makes them eligible to compete in F1200, F1600, or equivalents of no greater performance or closed wheel cars equal to or less than 2000 cc which are naturally aspirated.

#### 1.7 REDUCTION OF GRADE, SUSPENSION OR WITHDRAWAL OF LICENCE

Any licence issued by CASC-OR may be reduced in grade, suspended or withdrawn for sufficient cause at its sole discretion.

## **1.8 UNLICENCED ENTRY IN COMPETITION**

A Competitor who participates in a practice, qualifying or race session without a valid Race driver's licence shall be prohibited from competing in CASC-OR events for a period of up to 12 months.

## **1.9 EXPIRY OF COMPETITION LICENCES**

All Race licences expire on December 31 and become due for renewal on January 1.

## **1.10 ELIGIBILITY BY EVALUATION**

- a) Any licence applicant who has previously participated in some form of motorsport competition may apply directly to the Regional Chief Race Coach / Instructor or, in their absence the CASC-OR Race Director, for an evaluation of his or her experience and a decision as to what steps the applicant must take to receive a competition licence as set out in Section (c) below.
- b) The following information should be included in an application to the Regional Chief Race Coach / Instructor:
  - i. name and date of any motorsport school successfully completed with the certificate, if one was available;
  - ii. documentation providing the sanctioning body, number, type and date of competitions in which the applicant has competed. This may be in the form of a log card; finishing results/year-end standings; or a statement from a division director outlining the experience.
  - iii. an outline of any experience in motorsport as an official, crewmember, or any pertinent involvement;
  - iv. an application for the level of licence being requested.
- c) The decisions in these cases will be one, or a combination of, the following:
  - i. the applicant shall be issued a licence;
  - ii. the applicant shall be observed during the practice session of a race event and a decision made at that time as to whether a licence should be issued, or the applicant denied a licence at that time and therefore not allowed to continue in the competition;
  - iii. the applicant shall be directed to participate in an "open practice" or "test day" at which a licenced instructor approved by the Regional Chief Race Coach / Instructor is present who shall complete the "Observation Report" form;
  - iv. the applicant shall be directed to successfully complete the CASC-OR approved Race Procedures course and written exam for a race licence.
  - v. the applicant shall be directed to complete one of the available professional race schools approved by CASC-OR.
- d) Every effort shall be made to inform the applicant of any shortcomings which must be addressed before a licence can be issued.

## **2 RACE LICENCE MEDICAL CERTIFICATES**

### **2.1 MEDICAL REQUIREMENTS FOR COMPETITION**

Drivers shall not participate in any Competition unless they meet, and continue to meet, the medical requirements of the competition licence held. CASC-OR reserves the right to require a driver to submit a current medical examination report at any time. Drivers will not be permitted on-track until such a report has been received.

### **2.2 MEDICAL EXAMINATION**

Drivers shall submit the report of a medical examination performed by a medical practitioner at the time of the initial application for a driver's competition licence. Medical examination reports shall be submitted every five (5) years for drivers ages 15-35; every two (2) years for drivers ages 36-59; and every year for drivers age sixty (60) plus. The medical reports shall certify the applicant to be medically fit to drive a car in speed events.

In years not requiring a medical examination, drivers shall submit a self-declaration form attesting to their physical and mental fitness to participate in motorsports.

### 2.3 ACCEPTED DOCUMENTATION

A licenced medical practitioner using only a CASC-OR approved medical form shall complete all examinations. CASC-OR reserves the right to refer any submitted medical form to a licenced medical practitioner of its own choice for review.

### 2.4 VALIDITY OF MEDICAL CERTIFICATES

Medical certificates shall be valid for six (6) months from the date of issue.

## 3 RACE LICENCE GRADES

### 3.1 PROBATIONARY RACE LICENCE

Probationary Race Licences shall be issued to novice and reinstated drivers and shall be designed as Driver 'B'. A Probationary Race Licence is valid for Race Events sanctioned by CASC-OR. Drivers using a Probationary Licence will place a black triangle to the lower right-hand corner of each of their vehicle's numbers, clearly visible to race officials. Probationary Race Licences are intended as an interim licence, it is expected that drivers issued with a Probationary Race Licence shall request an upgrade during the first year of racing CASC-OR events.

### 3.2 REGIONAL RACE LICENCE

A Regional Race Licence is valid for Race Events sanctioned by CASC-OR and shall be designated as Driver 'A'.

### 3.3 TEMPORARY RACE LICENCE

A Temporary Race Licence is issued by the CASC-OR Race Director or Chief Race Coach / Instructor and is only valid for the Test Day and Event for which it has been issued. This Temporary Race Licence is issued prior to a Test Day and Event to observe the driver during the Test Day for the purposes of granting a **Probationary** Race Licence. Should the driver fail to perform satisfactorily, then they shall not be allowed to race during the event. Drivers seeking a Temporary Race Licence must ensure that their completed licence application is submitted five (5) days prior to the Test Day and Event.

### 3.4 RACE LICENCE REQUIREMENTS AND PROGRESSION

3.4.1 A Probationary Licence may be issued to:

- a) applicants who have graduated from a CASC-OR approved race school, passed a medical examination, and possess a current CASC-OR Club membership;
- b) applicants following an evaluation by the Regional Chief Race Coach / Instructor, or the CASC-OR Race Director;
- c) as the result of a reduction in licence level from a Regional Race Licence to a Probationary Race Licence as assessed by the Stewards, the Regional Chief Race Coach / Instructor, the Event Chief Instructor or the CASC-OR Race Director.

- 3.4.2 Drivers may advance to a Regional Race Licence only when they have requested and upgrade in writing and have been approved for an upgrade by the Regional Chief Race Coach / Instructor, or the CASC-OR Race Director. Probationary Drivers will then be observed for a minimum of three (3) Events. Drivers who have had their licence downgraded from a Regional Race Licence to a Probationary Race Licence will be observed a minimum of Two (2) Events or however many have been specified as being required at the time of the downgrade – whichever is greater.
- 3.4.3 An ASN Canada National licence requires having completed three (3) Events as a Regional Race licence holder and having been approved for upgrade by the Regional Chief Race Coach / Instructor or Race Director, in addition to the requirements of section 3.4.2 above.
- 3.4.4 A superior grade of licence is valid for all lesser categories.
- 3.4.5 At the sole discretion of the Regional Chief Race Coach / Instructor or the Race Director, a valid foreign Race licence may also be considered by CASC-OR as proof of adequate training for qualification for issuance of a CASC-OR Race licence, e.g., SCCA, MSA UK, at the sole discretion of the Regional Chief Race Coach / Instructor or the Race Director.

## 4 RACE LICENCE FEES

Licence fee information is available from the CASC-OR Office.

## 5 RACE OFFICIALS' LICENCES

Clerks, Assistant Clerks, Stewards of the Event, Scrutineers, Pit Lane Officials and Marshals shall hold CASC-OR Licences (See Race Regulations Section 4.1.3 Officials).

Details on the Curricula for all Race Officials are found in the CASC-OR Manual of Policies, Appendix A, found on the CASC-OR web site: <https://www.casc.on.ca/casc-or-documents/bylaws>.

### 5.1 OFFICIALS' LICENCE GRADES

There shall be two levels of licences for Clerks, Assistant Clerks, Stewards of the Event, Scrutineers and Pit Lane Officials:

- Grade A licence - Chief Race Officials.
- Grade B licence - Assistant Race Officials; Chief Race Officials - Drivers' Schools.

There shall be four levels of licences for Marshals:

- Probationary, Basic, Intermediate, Advanced.

### 5.2 OFFICIALS' LICENCE REQUIREMENTS

- 5.2.1 Licence holders shall be affiliated members of CASC-OR affiliated clubs.
- 5.2.2 Licence holders shall receive one signature on their Officials' Log Card from their department head or supervising Official per CASC-OR Race Event. One-day attendance shall qualify for a signature. Recognition for event experience as a Licence holder in these positions with other sanctioning bodies such as ASN Canada or an ASN Canada-affiliated Region can also qualify.
- 5.2.3 Licence holders shall submit a copy of their Officials' Log Card as the record of events worked when renewing a licence.
- 5.2.4 Licence holders wishing to renew a licence and who do not have the required number of signatures, or who have been absent from the sport for some time, may apply to CASC-OR for individual evaluation. This evaluation shall be conducted by a senior official in the speciality appointed by the Race Director. The evaluation shall consist of:
- a) a verbal discussion of current rules and practices for the speciality, and
  - b) observation of performance.

Every effort shall be made to inform the applicant of any shortcomings which must be addressed before a license can be issued.

### 5.3 STEWARD, CLERK AND SCRUTINEER LICENCE REQUIREMENTS AND PROGRESSION

For a Grade B Licence the candidate shall:

- a) provide a written resume of his/her motorsport experience including personal skills which will aid in the function of a Steward, Clerk or Scrutineer.
- b) attend a CASC-OR Stewards', Clerks' or Scrutineers' training session.
- c) satisfactorily complete the written open-book test.

Details on the Curricula for Clerk of the Course are found in the CASC-OR Manual of Policies, Appendix A, found on the CASC-OR web site: <https://www.casc.on.ca/casc-or-documents/bylaws>.

For a Grade A Licence the candidate shall:

- a) perform the duties of a B licenced Official in a competent manner at a minimum of three events per year for a minimum of two years.
- b) demonstrate a complete understanding of the role of a Steward, Clerk or Scrutineer at a CASC-OR Race Event.
- c) demonstrate leadership qualities.
- d) demonstrate an advanced knowledge of all CASC-OR rules and procedures.

To renew an A or a B licence the holder shall work as a licenced Official in a competent manner at a minimum of two regional level or higher Race Events per year with at least one in the specialty.

### 5.4 PIT OFFICIAL LICENCE REQUIREMENTS AND PROGRESSION

For a Grade B Licence the candidate shall:

- a) attend a CASC-OR Pit Official training class. Curricula for these training classes may be found in the CASC -OR Manual of Policies.
- b) satisfactorily complete the written open-book test.

Details on the Curricula for Pit Official are found in the CASC-OR Manual of Policies, Appendix A, found on the CASC-OR web site: <https://www.casc.on.ca/casc-or-documents/bylaws>.

For a Grade A Licence the candidate shall:

- a) perform the duties of a B licenced Official in a competent manner at a minimum of three events per year for a minimum of two years.
- b) demonstrate a good understanding of the role of a Pit Official at a CASC-OR Race Event.
- c) demonstrate leadership qualities.
- d) demonstrate an advanced knowledge of Pit rules and procedures and all other rules which might apply to the pits.

To renew an A or a B licence the holder shall work in a competent manner as a licenced Official at a minimum of two CASC-OR Race Events per year with at least one in the specialty.

It is advantageous to attend some events organized by clubs other than the licence holder's club.

### 5.5 MARSHAL REQUIREMENTS AND PROGRESSION

5.5.1 The holder of a CASC-OR Race Marshal's licence shall be an affiliated member of a CASC-OR affiliated club.

5.5.2 The holder of a CASC-OR Race marshal's licence shall nominate and be accepted by one accredited marshaling club for the purposes of record keeping, logbook issue, licence grading and training.



- 5.5.3 A Probationary licence requires attendance at both classroom and track-side schools approved by CASC-OR. Training shall include a basic fire training session. This grade of licence requires supervision while performing in the functions of flagging, phone/radio operation and safety. The accredited marshaling club's marshaling education committee shall keep written reports and evaluation for each event.
- Marshal education committees shall locally amend CASC-OR logbooks to include name and signature of corner senior / captain.
- Details on the Curricula for Marshals are found in the CASC-OR Manual of Policies, Appendix A, found on the CASC-OR web site: <https://www.casc.on.ca/casc-or-documents/bylaws>.
- 5.5.4 A Basic licence requires satisfactory reports from a minimum of 10 supervised race days as a Probationary licence holder. The accredited marshaling club's education committee shall review the written reports and judge if the marshal is capable of working with less supervision. In addition, the marshal shall pass a written, open-book test based on the CASC-OR Marshal's Training Manual with a reviewed and corrected mark of 100%.
- 5.5.5 An Intermediate licence requires:
- a) marshaling competently as a Basic licence holder for either a minimum of 40 race days at one track or 30 race event days including 6 race event days at another track;
  - b) demonstrating the competency required, in all marshaling functions at Canadian race events (flags, phones and safety).
- 5.5.6 Advanced Licence
- a) An Advanced licence requires marshaling for at least 40 race event days, including at least 10 days at tracks other than their home track, as an intermediate licence holder. In addition, the licence candidate shall have demonstrated, in all marshaling functions at Canadian race events (flags, phones and safety), the level of competency required for high speed, high profile events.
  - b) Once the requirements of Section 5.5.6 a) have been met, an application for an advanced licence can be accepted by the accredited marshaling club's education committee. The candidate shall be observed and assessed for a period of one year and a minimum of 10 race event days before being considered by their marshaling education committee for an advanced licence.
  - c) The Candidate shall have knowledge of blue flagging, but no requirement exists to be qualified as a blue flagger.
- 5.5.7 Chief Course Marshal, Captain/Senior and Blue Flagger should be considered specialities and should not be tied to licensing advancement. Consideration should be given to training personnel who wish to take the training and who have proven that they are capable of handling these responsibilities. The decision as to who gets trained in these specialities rests with the marshaling clubs' education committees.
- 5.5.8 Requests for licence upgrades shall be submitted in writing, with the required documentation, to the accredited marshaling clubs' education committees. The education committee shall decide if the candidate meets the prerequisites and shall recommend approval or denial of the request to CASC-OR. The committee shall advise the applicant of the recommendation.
- 5.5.9 To maintain an Intermediate or Advanced licence grade requires marshaling at least 6 CASC-OR race days per calendar year or else a downgrade of 1 level may be applied by the marshaling club's education committee. A maximum of two (2) Ice Racing event days may be counted towards this requirement.
- 5.5.10 A marshal who does not perform marshal duties for a year may be required to attend a marshal's school before a licence is issued. An absence of 2 or more years shall require attendance at a marshal's school.
- 5.5.11 Either of the following can veto a licence change with reasons in writing:
- a) Marshaling Education Chair of an accredited marshaling club
  - b) CASC-OR
- 5.5.12 An appeal of a decision to veto a licence change shall be submitted to CASC-OR in accordance with the applicable GCR.
- 5.5.13 Marshal's logbooks shall be issued only by an accredited marshaling club.

## 5.6 ACCREDITED MARSHALING CLUB

5.6.1 An accredited marshaling club shall meet the following conditions:

- a) the club shall be a CASC-OR affiliated club.
- b) the club shall have demonstrated that it is capable of holding a marshals' training session.
- c) the club shall have established a marshaling education committee led by a marshal holding an advanced marshal's licence and including at least two other members holding Intermediate or higher marshals' licences.
- d) the club shall have a procedure for the general operation of its marshaling program, including issuing and reviewing logbooks and approving licence upgrades.

5.6.2 A club shall apply to the CASC-OR Race Committee for accreditation as a marshaling club.

5.6.3 The following clubs are currently accredited:

- Canadian Race Communications Association (CRCA)
- Motorsport Marshaling Services (MMS)
- Motorsport Club of Ottawa (MCO)

## 6 Definitions

6.1.1 CASC-OR Race Event: A CASC-OR sanctioned road racing event.

6.1.2 Marshal Duties: Duties as described in Section 5.5 above, including Chief Course Marshal, Tower Phone for any FIA, FIM, RACE (or affiliate) sanctioned road racing event.

## APPENDIX F – MEDICAL, FIRE AND RESCUE

### 1 EQUIPMENT, VEHICLES AND PERSONNEL

During all Competition the following minimum emergency vehicles, equipment and personnel are mandatory:

- a) One physician to act as Chief Medical Officer and one trained medical person. A second physician, Registered Nurse, EMT, Paramedic or equivalent, trained in and equipped for life support procedures, may be approved by the CASC-OR Race Director as the trained medical person.

The physician and second medical person shall be available at Race Medical; they shall not participate in any Competition.

- b) One fully equipped Advanced Life Support (ALS) Ambulance, provided by an ambulance service licenced to perform urgent patient transfers by the Ministry of Health in the Province of Ontario.

If the ALS Ambulance is unavailable, then one Basic Life Support (BLS) Ambulance may be used ONLY if the Chief Medical Officer has access at the racetrack facility to the required medications for pain control and airway control.

- c) Fire/rescue/medical vehicles, equipment and crew as defined below.

### 2 OPERATING RULES

2.1.1 On track emergency vehicles dispatching methods shall be agreed upon prior to Competition.

2.1.2 The Chief Medical Officer shall be familiar with regulations, as dictated by the Provincial Coroner or Medical Examiner, pertaining to deaths which may occur during Competition. The Chief Medical Officer shall be familiar with the CASC-OR Concussion Protocols.

2.1.3 Medical / Rescue personnel should be identifiable by some means other than the usual passes to permit them to be clearly recognized.

2.1.4 All emergency equipment shall be readied and all on track emergency vehicles' engines shall be running for the first lap of all Competition. The crew shall be fully suited and within arms' reach of the vehicle while cars are on the track.

### 3 MEDICAL, FIRE AND RESCUE – MINIMUM REQUIREMENTS

#### 3.1 MINIMUM REQUIRED VEHICLES

3.1.1 There shall be a minimum of the following vehicles:

- a) Fire Vehicles shall be stationed so that, on an open track, under ideal conditions, the elapsed time from the moment the vehicle starts to move until it reaches the location of the next fire vehicle, at speeds not to exceed 80kph will not exceed one minute.
- b) One Recovery Vehicle ("Wrecker") capable of recovering any Car used in the Event is required.
- c) Track Ambulances may be used to transport the injured from the scene to Race Medical.

NOTE: A vehicle may be equipped and used for more than one purpose to meet the above requirements, e.g., one vehicle may be equipped as a Fire and Rescue vehicle, as a Track Ambulance and Rescue Vehicle, as a Track Ambulance and Fire Vehicle, or as a Fire and Rescue Vehicle and Track Ambulance.

3.1.2 PURSUIT VEHICLES

Pursuit vehicles shall not be used.

### 3.1.3 FIRE, RESCUE, AND MEDICAL VEHICLES – MINIMUM PERSONNEL

Each first response vehicle shall have at least two personnel with CASC-OR approved training in the use of the on-board equipment.

## 3.2 MINIMUM EQUIPMENT FOR FIRE VEHICLES

### 3.2.1 FIRE VEHICLES

Four 9Kg ABC fire extinguishers and two aqueous foam BC fire extinguishers per vehicle are required. At Events where Cars are fueled by alcohol or methanol, an additional two 11-liter pressurized water extinguishers per vehicle are required.

## 3.3 MINIMUM EQUIPMENT FOR RESCUE VEHICLES

### 3.3.1 RESCUE VEHICLES

- a) The following medical supplies are required:
  - i. cervical stabilization
  - ii. oral airways
  - iii. ambu-bag
  - iv. bandages and dressings
  - v. personal protective equipment
  - vi. 1 pair industrial gloves per crew member
  - vii. eye protection for each crew member
- b) The following Hydraulic Equipment is the minimum required:
  - i. 1 shear 90mm minimum jaw opening
  - ii. 1 rescue kit (expansion) 8/10 tonne capacity
  - iii. 1 wedge (small spreader) 750Kg, 90mm maximum jaw opening
  - iv. 1 large spreader 750Kg, 300mm maximum opening
- c) Hydraulic equipment shall be fitted with common male and female couplings.
- d) The following Hand Tools are required:
  - i. 1 quick release knife per crew member
  - ii. 2 hacksaws and non-breakable blades
  - iii. 1 small axe
  - iv. 2 pairs tin shears curved, one right pair and one left pair
  - v. 1 pair pliers
  - vi. 1 pair side-cutters
  - vii. 1 crowbar, 1m long
  - viii. 1 pair bolt cutters
  - ix. 1 pair vice grips
  - x. 1 Halligan tool

## 3.4 MINIMUM EQUIPMENT FOR TRACK AMBULANCES

### 3.4.1 TRACK AMBULANCES (WHERE USED)

Track ambulances (where used) shall be equipped with the following:

- a) stretcher
- b) full backboard
- c) short backboard
- d) cervical stabilization
- e) airway management kit
- f) oxygen
- g) suction
- h) bandage kit
- i) burn kit
- j) splints

### **3.5 MINIMUM EQUIPMENT FOR CORNER STATIONS**

#### **3.5.1 CORNER STATIONS**

Corner stations shall each be equipped with one 9kg or two 4.5kg ABC fire extinguishers.

## **4 RACE MEDICAL**

#### **4.1.1 THE MINIMUM REQUIREMENTS FOR THE MEDICAL ROOM ARE:**

- a) to be secure;
- b) to be heated;
- c) to be well lit;
- d) to be equipped with a working toilet;
- e) to have working hot and cold water;
- f) to have a working refrigerator with ice;
- g) to have a working telephone;
- h) to be equipped with a stretcher or equivalent;
- i) to be equipped with an additional bed;
- j) to have adequate electrical supply;
- k) to have communication access to race control;
- l) A shower is recommended.

## APPENDIX G – RULES OF THE PITS AND PADDOCK

### 1 PITS

#### 1.1 PROVISION OF PITS

A pit shall be provided for Cars, equipment, and Crew. Cars shall remain in the pits when not actually in Competition. During a Qualifying Session or a Race, repairs that cannot be performed safely in the pit area may – at the request of the Team Representative or Race Official – be performed in the paddock area only after requesting, and receiving, permission from the Clerk. This includes cars retired from Competition. Cars, which retire to the paddock, shall be ineligible to return to the Competition in progress unless the Series or Supplementary Regulations allows this, or permission is received from the Clerk.

#### 1.2 CHILDREN

Children younger than 16 years of age are not permitted in the pit lane, with the exception of drivers holding a Junior Regional Race Licence.

#### 1.3 ACCESS

Only Participants with proof of having signed the insurance waiver may be track-side, or in any posted restricted area.

#### 1.4 RACE START

At the start, or re-start, of a Race, only the pit marshals are permitted in the pit lane.

#### 1.5 APPAREL

All personnel in the pit lane shall have their body covered. All clothing shall be appropriate to the environment, e.g., shoes that allow movement, support and protection for the foot, with no exposed skin; shirts with sleeves; long pants; socks, etc. In addition, individuals designated as Pit Officials shall wear a fire-retardant, high visibility **white**, lime green, or bright orange vest or coveralls.

#### 1.6 SMOKING

Smoking or vaping is forbidden behind the pit counter, in pit lane and in any open stands immediately above the pits.

#### 1.7 SPACE ALLOTTED

Cars, crews and equipment may not occupy more space than that designated as that Car's pit.

#### 1.8 CARS OVERSHOOTING THE PIT

Cars shall not back up under their own power. They shall be pushed back by hand or continue for another lap.

#### 1.9 FIRE EXTINGUISHER REQUIREMENTS

4.5kg ABC fire extinguishers shall be placed at 15-metre intervals along the pit lane. The location shall be visible to people in pit lane.

## 1.10 PETS

Pets are prohibited in the pits.

## 1.11 PIT LANE SPEED LIMIT

A speed limit of 60kph shall be observed in the Pit Lane zone, demarcated by the first and last radar devices used to measure the speed or as specified in the Supplementary Regulations.

## 1.12 PHOTOGRAPHY

Photography is not permitted in the pit lane except by the specific permission of Clerk.

## 1.13 BLEND LINE

1.13.1 A blend line shall be marked on the track from Pit Out extending on to the track. The purpose of this line is to assist in the safe entry to the track.

1.13.2 **Except in cases of force majeure**, drivers exiting the pits **and** drivers on the track shall ensure that none of their tires touch this blend line.

## 1.14 AUXILIARY POWER

Only Cars equipped with permanent externally mounted receptacles may use auxiliary power (battery assist) during Competition.

## 1.15 EMERGENCY/SERVICE VEHICLES IN PIT LANE

Moving emergency or service vehicles may not be passed in the pit lane unless directed by an Official.

## 1.16 DRIVER CREW AT PIT WALL

At any time a Car is on the course, two persons may be at the wall separating the racecourse from pit lane for the purpose of signaling the driver in the Car.

## 1.17 DRIVER CREW DURING PIT-IN

One person may go over the pit counter to signal their Car to its pit for a pit stop. All other team members shall remain behind the counter until the Car comes to a complete stop.

## 1.18 DRIVER CREW DURING PIT STOP

No more than five team members may be over the wall to perform service on a Car at any time. Not counted in this number is:

- a) a driver seated in the Car;
- b) a driver preparing to get in the Car (when allowed by Series Regulations);
- c) the signal persons at the wall separating the track from the pits provided these persons do not move from this position;
- d) the team fire extinguisher person (when allowed by Series Regulations).

## 1.19 JACK STANDS

No work shall be performed under a car unless the car is supported by jack stands or on-board jacking system with positive mechanical locks.

## 2 FUEL STORAGE AND REFUELING

Fuel Transfer – ANY transfer of fuel must include a separate designated person whose sole function shall be to oversee the refueling process while holding an appropriate and armed fire extinguisher. Refueling will not be performed under an awning or where fumes could accumulate.

### **3 STORAGE CYLINDERS FOR COMPRESSED GAS**

#### **3.1.1 ANY STORAGE CYLINDERS FOR COMPRESSED GAS SHALL:**

- a) be secured in position during transportation, storage or use
- b) if stored on their side be chocked or wedged to prevent motion
- c) have the valve protection cap in position when not in use
- d) have a valve protection cage in position when in use
- e) when containing acetylene always be in a valve end up position
- f) shall not be in Pit Lane
- g) Portable air tanks and fire extinguishers are exempt from the above regulations but shall be handled and stored in such a manner as to avoid damage to the unit.

### **4 PADDOCK**

#### **4.1 FACILITIES**

A paddock area with sanitary facilities shall be provided for the use of Competitors.

#### **4.2 PETS**

All pets shall be leashed to an adult or a fixed location with a maximum 3-metre line or be kept in an enclosed space.

#### **4.3 CHILDREN**

Parents and guardians are responsible for the safety of their children.

#### **4.4 NOISE REGULATION**

Control of Cars, Competitors, children, pets and excessive noise shall be exercised in both the paddock area and the camping area. Noise will be regulated as described in the Event Supplementary Regulations.

#### **4.5 RACETRACK PERMISSION**

Vehicles are not permitted on the Racetrack at any time except by permission of the Clerk or the Track Manager. This includes before, during and after an Event.

#### **4.6 PADDOCK ROADS**

Paddock roads shall be kept clear of Cars in order to provide unhampered access for tow trucks and/or service vehicles. A speed limit of 10 km/h shall be enforced. Burnouts, donuts and other extreme forms of driving are specifically prohibited.

#### **4.7 FIRE EXTINGUISHERS**

One 4.5Kg ABC rated fire extinguisher shall be placed in the False Grid area and one in the Scrutineering and Impound Areas.

#### **4.8 MOTORIZED VEHICLES**



- 4.8.1 Motorized vehicles (including quad bikes) may be driven behind the Pits or in the Paddock and False Grid areas only by a road traffic licence holder who is on specific race team business.
- 4.8.2 Recreational use is strictly prohibited.

DRAFT

## APPENDIX H – FLAG AND LIGHT SIGNALS AND RULES OF THE ROAD

### 1 GENERAL

Signals are given in daylight by different coloured flags, possibly aided by lights. Yellow lights at each marshal's post are obligatory for Events run at night.

### 2 FLAG SIGNALS: MINIMUM SIZE

The minimum size of the signaling flags is 600mm x 800mm. The red flag will measure 800mm x 1000mm.

### 3 FLAGS USED EXCLUSIVELY ON THE INSTRUCTIONS OF THE CLERK

#### 3.1 STARTING FLAG

The Green Flag, the Canadian National flag, or an approved light system shall be used.

#### 3.2 BLACK AND WHITE - CHECKERED FLAG

Indicates the end of a Competition session when waved at the finish line or other location specified in the Supplementary Regulations.

#### 3.3 RED FLAG

3.3.1 Waved at all marshal posts and by the Starter, it informs all Drivers to cease racing, slow down significantly from normal speed, stay to driver's right of the track and be alert for response vehicles, recovery vehicles or clean up vehicles entering from any of their locations and prepared to stop at any time. For warm-up, practice or qualifying sessions, proceed around to pit lane unless directed otherwise by officials. For races, proceed around the Course to the Start/Finish, **permitting sufficient space for regriding cars**, remaining on-track unless directed otherwise by officials. The lap on which the flag is displayed will not be scored.

3.3.2 When displayed at pit out informs the driver that they cannot exit from pit lane to the track.

#### 3.4 BLACK FLAG

3.4.1 Held steady and displayed **by the Starter** or other location specified in the Supplementary Regulations and accompanied by a number on a board, it informs the Driver of the Car designated by that number, to return to the pits at the conclusion of the current lap and await instructions from the Officials.

3.4.2 Held steady and displayed **by the Starter** accompanied by the word "ALL" on a board, and at all marshal posts, informs all Drivers that the current Course session has been halted and that they shall return to the pits at the conclusion of the current lap. Drivers shall be prepared to stop at any time.

#### 3.5 BLACK AND WHITE FLAG

3.5.1 Divided diagonally into black and white halves, shown motionless **by the Starter** and other location if specified in the Supplementary Regulations, and accompanied by a number on a board, it informs the Driver of the Car designated by the number that his/her conduct or driving has been observed as being unsporting or unsafe. It is a warning; if the behavior continues the Driver may be shown the Black Flag.

#### 3.6 BLACK FLAG WITH ORANGE DISK – 'MECHANICAL BLACK FLAG'

3.6.1 The orange disk shall be 400mm in diameter. Shown motionless **by the Starter** or other location specified in the Supplementary Regulations, and accompanied by a number on a board, it informs the Driver of the car designated that the Car has mechanical problems likely to endanger the Driver or others. The Driver shall stop at his/her pit on the next lap.

### 3.7 USE OF THE STARTER'S STAND AS A FLAG STATION

The Starter's stand shall not normally be used as a flag station. The Clerk may, in unusual circumstances, direct the Starter to act as a flag station.

## 4 FLAGS USED AT MARSHALS' POSTS

Flags used by the marshals may be shown either motionless or waved. A waved flag emphasizes the flag's basic meaning.

### 4.1 YELLOW FLAG

4.1.1 The yellow flag is a signal of danger of any nature at or beyond the station displaying the flag. SLOW DOWN.

The "Yellow No Passing Zone" begins at the Flag Station where the yellow flag is shown and extends in a perpendicular imaginary line over the track surface and runoff area. It ends after a second perpendicular imaginary line across the track surface at the first Flag Station displaying a green flag. PROCEED THROUGH YELLOW ZONE IN SINGLE FILE, WHICH MAY BE STAGGERED.

4.1.2 Yellow flags may be shown in 4 ways:

a) ONE FLAG MOTIONLESS

When the yellow flag is shown "motionless" it shall be moved with a side-to-side rocking motion.

The course is unobstructed.

OR, there is an obstruction located off the course or in the next sector.

OR, the following post is displaying yellow flag(s).

When the obstruction will remain in position for the remainder of the session the yellow flag shall be shown motionless for two laps and then withdrawn.

b) ONE FLAG WAVED

The course is obstructed. The obstruction is located on or immediately adjacent to the course. Workers may be on or near the course.

The corner captain or the Clerk may request preceding posts to display a motionless flag.

When the obstruction will remain in position for the remainder of the session the yellow flag shall be waved for two more laps, shown motionless for two laps and then withdrawn.

c) TWO FLAGS WAVED

Be prepared to stop.

The course is seriously or completely obstructed. Workers may be on the course.

The corner captain or the Clerk may request preceding posts to display a motionless flag.

d) TWO FLAGS MOTIONLESS AT ALL STATIONS AND **BY THE STARTER**

Slow down significantly, stay to driver's right of the track and be alert for response vehicles, recovery vehicles or Safety Car entering the track from any of their locations. This may occur with or without the Pace/Safety Car. **Also known as full course yellow.**

Yellow flag procedure for restarts can be found in Race Regulations Section 2.6.

4.1.3 If the pit lane exit is within a yellow zone, the Pit-Out marshal may mirror the yellow flag status of that zone.

4.1.4 When necessary, during the display of a yellow flag, drivers shall be instructed by means of hand signals to keep to the side of the Course that is not obstructed.

4.1.5 During full course yellow situations, the pit exit shall be closed each lap when the Safety Car passes the Starters Stand. The pit exit shall remain closed until the main pack has passed the pit exit.

4.1.6 Under full course yellow, it may be permissible to pass a slow car with an obvious problem.

## 4.2 YELLOW FLAG WITH RED STRIPES

The yellow and red striped flag informs Drivers to take care. It is used to warn of a slippery surface such as caused by the presence of oil, water and/or debris on the Course surface.

The flag shall be displayed for four laps or until the surface returns to normal.

## 4.3 GREEN FLAG

A waved green flag may be shown for two laps replacing the yellow flag(s) at the site of an incident once the Course has been cleared.

## 4.4 WHITE FLAG

4.4.1 The white flag informs Drivers that they are about to overtake a vehicle which is travelling on the Course at a much slower speed than the Competitors. The white flag shall be shown when a service vehicle is on the Course or when a competing Car is moving at a reduced speed.

4.4.2 The white flag shall be waved as soon as the slow-moving vehicle has gone past the flagger's post and this shall continue until the vehicle reaches the following post, and then shown motionless while the vehicle is crossing the next sector then withdrawn. If the vehicle stops on the Course, the white flag shall immediately be replaced with a yellow flag.

## 4.5 BLUE FLAG

The blue flag informs Drivers that they may be about to be overtaken by a faster Car. When the blue flag is waved, it draws the Driver's attention either to the closeness of the Car about to overtake, or to the high speed at which it is approaching.

The blue flag may be shown motionless when the faster Car is still some distance away and when the flag marshal feels that overtaking will take place in the following sector.

# 5 LIGHT SIGNALS

## 5.1 SPECIFICATIONS

When light signals supplement flag signals, they shall comply with the following specifications:

- a) The light signals may replace the yellow, green and red flags.
- b) The installation shall present three grouped lights, two yellow and one green. The yellow lights shall be spaced so as to ensure that the presence of two lights is easily recognizable. A red light may be included, to be operated solely by Race Control simultaneously with red lights at all other posts.

## 5.2 MEANINGS

Steady lights shall have the same meaning as steady flags and flashing lights shall have the same meaning as waved flags.

## 5.3 REQUIREMENTS FOR NIGHT RACING

For night racing – as defined in the Event's Supplementary Regulations – there shall be, at minimum, yellow lights controlled by each post.

# 6 SIGNBOARDS USED BY THE STARTER

The starter may display any of the following signs from the start bridge.

- a) Lights On – Shown at the request of the Clerk of the Course, all drivers must turn on their rain lights. See Appendix N – Car Preparation, Section 11.

- b) Pit Window Open – Indicates that the window for the mandatory pit stop is open under Endurance Racing rules, Appendix Q – Endurance Race Regulations, Section 6.
- c) Last Lap – Shown to the leader and all following competitors to signal that they are starting the last lap of the race. See Race Regulations, Section 2.3.12.

## **7 RULES OF THE ROAD**

### **7.1 ENTERING THE PITS**

Before entering the pits from the Course, Drivers shall signal by raising an arm.

### **7.2 SIGNALING TO PASS**

If a Driver about to be overtaken wishes to indicate the side on which an overtaking Driver should pass, they shall point to that side or operate the signal light on the side on which the pass should be carried out.

### **7.3 DIRECTION OF TOW**

During a session it is forbidden to drive or tow a Car in a direction opposite to that in which the Event is being run without the specific approval of the Clerk.

### **7.4 STOPPING ON THE COURSE**

If a Car stops on the Course during an Event, the Car should be parked in such a manner as to cause no obstruction to other Competitors.

### **7.5 MOVEMENT UNDER POWER OF THE VEHICLE STARTER**

Cars shall not be moved under power of the starting device while on the Course, except to remove them from a hazardous position to one of greater safety.

### **7.6 ASSISTANCE**

Drivers shall obtain no assistance during the Race other than from their pit Crews in the pits. This does not preclude assistance by Officials for safety reasons.

### **7.7 DRIVING OFF COURSE**

The Driver is required to follow the marked Course during a Competition and shall not gain an advantage from an off-Course excursion.

### **7.8 OVERTAKING**

- 7.8.1 Overtaking drivers are responsible for the decision to pass another car and to accomplish the pass safely. Overtaken drivers are responsible for being aware that they are being overtaken and shall not deliberately impede the overtaking car.
- 7.8.2 Competitors have a right to "racing room" on the racetrack. "Racing room" is defined as sufficient space on the racetrack to allow competitors to maintain control of their cars in close quarters, under racing conditions. Maneuvers liable to hinder other drivers, such as deliberate crowding of a car beyond the edge of the track, are prohibited.
- 7.8.3 'Blocking' is defined as being 'Movement in Reaction' to changes of line of following driver(s).
- 7.8.4 Competitors shall avoid physical contact with other competitors' cars.

### **7.9 REPETITION OF DRIVING ERRORS**

Repetition of serious driving errors or a lack of control over the Car may incur penalties.

## 7.10 RIDING OUTSIDE THE COCKPIT AREA

No one shall ride outside the cockpit area or on the coachwork of any car at any time, including victory laps.

## 7.11 DRIVER SIGNAL AFTER AN ON-TRACK INCIDENT

- 7.11.1 Drivers involved in an incident that results in their vehicle coming to a complete stop who do not continue should attempt to provide one of the following signals as soon as practicable to inform track officials that they do not require emergency assistance.
- 7.11.2 Drivers of open wheeled vehicles and/or roadsters should attempt to raise their visor, keep it in the open position, and try to establish direct eye contact with the nearest official.
- 7.11.3 Drivers of closed wheel vehicles should attempt to drop their window nets and should attempt to establish eye contact with the nearest official.

## 7.12 DROPPING OIL

- 7.12.1 A competitor who drops oil on the racing surface, may be subject to a penalty if it is determined that the competitor obviously and knowingly continued driving in order to return to the pits, instead of pulling off track in a safe area.

## 7.13 DRIVING A DISABLED CAR

- 7.13.1 *If a driver feels/knows there is a problem with their car they should indicate this to following drivers by
  - a) raising a hand or pointing,
  - b) putting on the rain light or hazard lights if the car is so equipped*
- 7.13.2 *The driver should keep to one side of the track and off the racing line and allow cars to pass safely.*
- 7.13.3 *This includes when under full course yellow or behind the Pace Car or Safety Car. Following drivers may pass the car signalling it is disabled.*

## APPENDIX I – DRIVER SAFETY EQUIPMENT

### 1 USE OF DRIVER SAFETY EQUIPMENT

The use of the following Driver safety equipment is mandatory during all Competition.

Drivers and passengers in Racing Driver Schools shall wear helmets as specified herein.

It is the responsibility of the Driver/Entrant to ensure that the manufacturer's instructions for the use and care of safety-related items are followed.

#### 1.1.1 SFI LABELS

Starting in 2017, the expiration dates ("Valid Until") of SFI equipment (drivers restrains, window nets, roll cage nets) are now printed on the label instead of using punched-out manufacturing date.

#### 1.1.2 *Withdrawal of Approval*

***Check safety equipment against the list of equipment with withdrawn approval. The list is posted to the CASC-OR web site.***

<https://www.casc.on.ca/sites/default/files/Documents/CASC-OR%20List%20of%20Withdrawn%20Approvals%20-%20DRAFT.pdf>

### 2 CLOTHING

#### 2.1 DRIVER SUITS AND UNDERWEAR

2.1.1 One-piece driver suits that effectively cover the body from the neck to the wrists and ankles, manufactured of material approved herein, shall be worn.

2.1.2 Underwear manufactured of material approved herein shall be worn, where specified in Section 4.0.

2.1.3 Driver suits and underwear shall be clean and in good condition with no excessive oil stains, holes or frayed edges.

#### 2.2 GLOVES

2.2.1 Gloves shall meet or exceed the following criteria:

- a) Gloves made of material approved herein shall be worn;
- b) Gloves shall have no holes or perforations;
- c) Gloves shall be fitted at the wrist and shall cover the cuff of the driver suit;
- d) any leather used on the exterior of the glove may only contact the skin through the seams;
- e) any leather used on the interior of the glove shall be separated from the exterior by fabric approved herein;
- f) any leather used may not form a continuous loop around any portion of the hand.

2.2.2 Gloves bearing the official marking to show compliance with SFI Standard 3.3/5, or FIA Standard 8856-2000 are accepted.

### 2.3 SOCKS

Socks made of material approved herein shall be worn.

### 2.4 SHOES

Shoes made of material approved herein and/or of leather shall be worn.

### 2.5 BALACLAVAS AND HELMET SKIRTS

2.5.1 Balaclavas, or helmet skirts with full face helmets with visor down, made of material approved herein shall be worn. It is recommended that balaclavas be double layers.

2.5.2 Hair protruding from beneath helmets shall be completely covered.

### 2.6 HELMETS

#### 2.6.1 ACCEPTED EQUIPMENT

The following helmets are accepted:

- a) Snell SA 2010 / SA 2015 / SA 2020
- b) Snell SAH 2010
- c) SFI 31.1
- d) SFI 31.1A
- e) SFI 32.2A
- f) **FIA 8860-2010**
- g) **FIA 8860-2018**

Note: Effective January 1, **2024** Snell SA 2010, SAH 2010 **and SA2015** helmets will no longer be accepted for drivers in CASC-OR Road Racing.

#### 2.6.2 CONDITION OF HELMETS

Helmets shall be in good condition.

#### 2.6.3 REPAIRED HELMETS

A repaired helmet may be approved provided that written proof of a satisfactory repair by the helmet manufacturer is presented.

#### 2.6.4 OPEN CARS

Full-face helmets and shields shall be worn by drivers of open cars and are strongly recommended for all drivers.

### 2.7 FHR (FRONTAL HEAD RESTRAINT) DEVICES

#### 2.7.1 ACCEPTED EQUIPMENT

FHR devices meeting the following standards are accepted:

- a) FIA Standard 8858
- b) SFI Specification 38.1

## 3 APPROVED MATERIALS

All fire-resistant material approved by ASN Canada, FIA, SCCA and SFI is acceptable.



## **4 DRIVER SUITS AND UNDERWEAR SYSTEMS**

### **4.1 APPROVED SYSTEMS**

The following driver suit/underwear systems are approved:

- a) suits of two layers of approved material worn with approved underwear;
- b) suits of three layers of approved material;
- c) suits carrying an SFI 3-2A/3 rating, SFI 3-2A/5 single layer suit, or FIA approved single layer suits worn with approved underwear;
- d) multi-layer suits carrying an SFI 3-2A/5 or higher rating;
- e) multi-layer suits carrying an FIA Homologation;
- f) suits, which the manufacturer states in writing meet or exceed the standards stated herein, may be substituted for that standard.
- g) It is highly recommended that underwear of approved material be worn under all Driver suits.

### **4.2 RESTRICTED MATERIALS**

While competing, drivers should not wear any clothing composed in whole or in part of Nylon.

### **4.3 PROOF OF COMPLIANCE**

In the case of doubt concerning the composition of a suit/underwear system, the Driver shall be able to present adequate evidence that it conforms to one of the above standards.

## **5 EYE PROTECTION - RECOMMENDATIONS**

It is recommended that any corrective eyeglass material or sunglasses be of the safety glass type.

## APPENDIX J – TECHNICAL INSPECTION

### 1 CAR LOGBOOKS

#### 1.1 RECOGNIZED LOGBOOKS

All Competitors at CASC-OR Events shall have a logbook issued by a recognized sanctioning authority.

#### 1.2 VALID LOGBOOKS

Only one logbook shall be issued for each Car (other than an extension or replacement).

#### 1.3 ISSUANCE OF LOGBOOKS

A logbook shall be issued by a CASC-OR licenced scrutineer who shall conduct a thorough inspection of the Car and enter a complete description of the Car, its safety roll cage and the required photographs. All changes of ownership shall be entered.

#### 1.4 IDENTITY PLATE

Each Car shall be identified by a CASC-OR issued Identity plate permanently attached to the Car frame bearing a number corresponding to that of its logbook.

### 2 TECHNICAL AND SAFETY INSPECTION

#### 2.1 ANNUAL INSPECTION

A full and complete technical and safety inspection (Annual Inspection) shall be performed on each Car once a year. The year shall be defined as the calendar year. When the Car passes this inspection, the logbook shall be stamped with the "official" Annual Inspection stamp and dated and signed by a licenced CASC-OR scrutineer.

#### 2.2 INSPECTION AT EVENTS

##### 2.2.1 PRESENTATION

The logbook shall be presented in registration at the Event signed by the Competitor. When the logbook contains verification of a current Annual Inspection, and no subsequent damage notation an Event scrutineering sticker shall be issued to be attached to the Car during competition. If the annual inspection is not current, or there is a subsequent damage notation, the logbook must be presented to the Event Scrutineer for the Event scrutineering sticker to be issued prior to entering competition. On Formula Cars, Sports Racing Cars and GT Cars with no roof the sticker shall be placed on the roll bar to the right of the driver's head. On GT Cars the sticker shall be placed on the top right-hand corner of the windshield.

2.2.2 When the logbook does not contain verification of a current Annual Inspection, the Car shall be presented to the Event scrutineers and an Annual Inspection shall be performed prior to the issue of an Event scrutineering sticker. Such an inspection shall not delay inspection of Cars which have had an Annual Inspection done.

2.2.3 When the logbook contains a scrutineer's notation regarding a defect, the results of a protest noted after the Annual Inspection, or when the logbook indicates no Competition for an extended period of time (3 months or more) during a year the Car shall be presented to the Event scrutineers for inspection prior to the issue of an Event scrutineering sticker for the Car.

- 2.2.4 When the logbook is not available at scrutineering, the Car shall be accepted for Competition only after a thorough inspection during which all details required for the issue of a logbook shall be recorded. This inspection shall not delay inspection of Cars, which have logbooks available. Competitors shall arrange with the Event scrutineers an appropriate time for inspection of their Car prior to being accepted for Competition.
- 2.2.5 Deviations Regarding Safety
- a) All deviations regarding safety shall be entered in the logbook.
  - b) If a waiver for the Event is permitted this shall be entered in the logbook and complied with by the Competitor.
- 2.2.6 When a Car is protested during an Event and found to be illegal, the results of the protest shall be entered in the logbook.
- 2.2.7 When a Car is damaged during an Event, a description of the damage shall be entered in the logbook.
- 2.2.8 When a Car has been altered or damaged after issue of an Event scrutineering sticker the scrutineer may remove the sticker until the Car has been re-inspected and re-approved.

### **2.3 CLASS SCRUTINEERING**

At each Event, certain classes shall be designated to be presented to the Event scrutineers.

### **2.4 RANDOM SCRUTINEERING**

Event scrutineers shall carry out random technical inspections of Cars and of Drivers' safety equipment and clothing for safety and eligibility purposes at any time during the Event.

## **3 OFFICIAL SCALES**

### **3.1 DESIGNATION**

- 3.1.1 The scales at the Event are the official scales of the Event.
- 3.1.2 Platform scales or individual scales, which weigh one axle (two wheels) at a time or each wheel separately, are acceptable.
- 3.1.3 Official weigh scales shall be available for Competitors' use 1 hour prior to the first qualifying session for those classes that have a minimum weight requirement, on both Saturday and Sunday, and until thirty (30) minutes after the final race for the last class with a minimum weight rule.

### **3.2 CAR WEIGHT**

Cars found to be underweight shall have this noted in the logbook.

## **4 IMPOUND**

### **4.1 NOTICE OF IMPOUND**

- 4.1.1 The Clerk may direct Cars to be impounded pending inspection and disassembly to check compliance with the Regulations.
- 4.1.2 When Cars are to be impounded immediately following Competition, notice of such impounds shall be given to the Competitor prior to leaving the pit lane.

### **4.2 RESPONSIBILITY**

- 4.2.1 The Competitor shall be responsible for performing all required disassembly and reassembly.

4.2.2 If the Car is found to be eligible for the competition in which it is entered the Event organizer shall stand the expense of the disassembly, inspection and reassembly.

4.2.3 If it is not eligible the Entrant shall bear the expense.

### **4.3 SUPERVISION**

The disassembly shall be carried out under the supervision of the Chief Scrutineer of the Event, or his/her designate. The required inspections shall be carried out by the Chief Scrutineer of the Event or by a suitably qualified designate approved by the Clerk. The Chief Scrutineer shall communicate the results of the inspections in writing to the Clerk only.

### **4.4 FINDINGS**

The Clerk shall report the results of the inspections to the Stewards of the Event, requesting a penalty should the Car be found to not conform to the Regulations.

### **4.5 POSTPONEMENT OF DISASSEMBLY AND INSPECTION**

If it is decided by the Clerk that disassembly and inspection is not immediately possible, the inspections may be carried out at another time and place as designated by the Clerk. The components of the Car to be inspected are to remain impounded until such inspection is completed. This may be done by having them remain in the possession of the Chief Scrutineer of the Event or by having them sealed or by any other means deemed satisfactory by the Clerk and the Stewards of the Event. Costs incurred will be the responsibility of the Competitor. A car impounded in this manner shall be kept for a reasonable length of time as agreed upon by the Scrutineer, the protestor and the driver of the protested car. A sealed component may be worked upon under the supervision of a licenced scrutineer approved by the three people mentioned above.

## **5 PROTESTS AND TEARDOWN BONDS**

### **5.1 ELIGIBILITY FOR PROTEST**

Entrants may protest a Car that they believe does not conform to the Regulations. They may request in their protest that the Car be disassembled, inspected or tested by Officials in order to determine if it complies with the Regulations.

### **5.2 TEARDOWN**

5.2.1 The Stewards of the Event, in conjunction with the Chief Scrutineer, shall determine if a teardown is required and if so, the estimated cost of such a teardown.

5.2.2 The amount of the bond shall be adequate to cover the cost of disassembly, examination, measurement, rebuild and transportation to an alternative specified location.

5.2.3 A bond covering this cost shall be given to the Stewards of the Event by the protestor prior to the protested vehicle being disassembled and inspected.

### **5.3 COMPLETION OF TEARDOWN**

Teardowns and inspections shall be completed as specified in the protest, regardless of determination of illegality at any earlier point in the proceedings.

### **5.4 WHERE LEGALITY IS DETERMINED BY TEARDOWN**

If the Car is found to conform to the Regulations, the bond shall be used to cover all of the costs incurred by the protest. Any shortfall/surplus shall be charged to/returned to the competitor lodging the protest.

## **5.5 WHERE ILLEGALITY IS DETERMINED BY TEARDOWN**

If the Car is found not to conform to the Regulations, the Entrant of the protested Car shall be responsible for the costs incurred for the disassembly and reassembly and the bond shall be returned to the protestor.

## **6 MEASUREMENTS**

### **6.1 IMPOUND**

If a car is protested and has to be disassembled to be inspected, tested or measured, then those parts of the car shall be sealed or impounded until the necessary inspections, tests or measurements can be made by a qualified person designated by CASC-OR.

### **6.2 RESPONSIBILITIES**

The driver whose car is protested shall be responsible for delivering the car to the place where the inspection, test or measurement is to be carried out.

DRAFT

## APPENDIX K – FUEL, FUEL CELLS AND TANKS

### 1 FUEL

#### 1.1 PERMITTED FUELS

All Cars shall run on fuel produced by a recognized commercial manufacturer unless otherwise specified by Class, Series or Supplementary Regulations.

#### 1.2 ADDITIVES

1.2.1 The addition of compounds containing nitrogen and/or oxygen is prohibited.

NOTE: Competitors are advised that some chemicals used as fuel additives are classified as probable or suspected human carcinogens, or have been implicated in several deaths. Some of these chemicals are propylene oxide, ethylene oxide and para-dioxane, also known as 1.4 dioxane.

### 2 FUEL CELLS/TANKS

#### 2.1 DEFINITION

2.1.1 A Fuel Cell is defined as consisting of an inner bladder/tank, manufactured to FIA FT3 specifications, or better, approved fuel cell foam and a metal container as specified herein.

2.1.2 A Fuel Tank is defined as consisting of a cross-linked polymer tank intended for use as a fuel tank in a race car, approved fuel cell foam and a metal container as specified herein.

#### 2.2 CLASS REQUIREMENTS

2.2.1 Fuel Cells/Tanks, as defined above, are required for all Formula Cars, Sports Racers, tube-frame GT Cars and GT and Touring Cars built from a production road car, model year 1981 or earlier. Sports Racing Cars with an FIA Approved main chassis are exempt from this requirement. These cars may use the fuel cell/tank defined above, or they may retain the fuel cell/tank supplied by the car manufacturer.

2.2.2 GT and Touring Cars built from a production road car, model year 1982 or later, may use a Fuel Cell/Tank as specified above, OR, if a minimum of 30 cm of the original structure surrounding the stock Fuel Tank is retained and this structure is welded to the adjacent tubular steel replacement frame members, the stock tank may be used. Fuel cell foam may be added to the stock tank.

#### 2.3 SIZE, NUMBER AND CAPACITY

2.3.1 The dimensions and capacity of Fuel Cells/Tanks are free unless otherwise specified by Class, Series or Supplementary Regulations.

2.3.2 The installation of more than one Fuel Cell/Tank is permitted.

#### 2.4 LOCATION

##### 2.4.1 FORMULA AND SPORTS RACING CARS

The location is free unless otherwise specified by Class, Series or Supplementary Regulations.

##### 2.4.2 CLOSED-WHEEL CARS

- a) Fuel Cells/Tanks shall be installed as close as possible to the location of the standard tank(s), except when safety considerations, dimensional limitations, or other factors make this impractical, impossible or undesirable.
- b) Fuel Cells/Tanks shall not be located in the Driver/passenger compartment.
- c) Fuel Cells/Tanks shall be installed not less than 15cm (6in) from the ground unless enclosed within the bodywork or chassis.
- d) Fuel Cells / Tanks, the fittings for fuel lines, fittings for refueling and fuel vent lines directly attached to the fuel cell / tank shall be isolated from the drivers compartment by a fire-proof barrier such as a metal bulkhead or enclosure.

#### 2.4.3 VINTAGE CARS

CASC-OR may approve alternative locations for individual Cars upon request.

### 2.5 DESIGN DETAILS AND MATERIAL SPECIFICATIONS

#### 2.5.1 BLADDERS

Bladders shall be manufactured to FIA FT3 specifications, or better. Foam internal baffling is required.

#### 2.5.2 CONTAINERS

- a) Bladders and Cross-Linked Polymer tanks shall be installed in a container fully surrounding the bladder/tank, constructed of 0.036-inch-thick steel or 0.059-inch-thick aluminum. All seams of this container shall be securely fastened.
- b) In Formula Cars and Sports Racing Cars the containers may form part of the structure of the bodywork of the Car.
- c) In Closed Wheel Cars internal body panels may be modified to accommodate the installation of Fuel Cells/Tanks provided such modifications serve no other purpose.

#### 2.5.3 FITTINGS

All fittings shall be built into the bladder and bonded and cured as an integral part of the bladder.

## APPENDIX L – DRIVER RESTRAINT SYSTEMS

### 1 GENERAL PROVISIONS

- 1.1.1 **Except for** Driver Schools, all Drivers shall utilize a restraint harness manufactured to FIA/ISO Standard No. **8853/98, 8853-2016**, SFI Spec. 16.1, or SFI Spec 16.5 **except for the any items on the list posted in the CASC-OR List of Withdrawn Approval Equipment which is posted below.**

<https://www.casc.on.ca/sites/default/files/Documents/CASC-OR%20List%20of%20Withdrawn%20Approvals%20-%20DRAFT.pdf>

- 1.1.2 Restraint harness installations are subject to the approval of the Chief Scrutineer at each Event.
- 1.1.3 It is the responsibility of the Driver/Entrant to ensure that the manufacturer's instructions for installation, use and care of safety-related items are followed.

### 2 DESIGN

A minimum five-point system is required for use in Cars where the Driver is seated in an upright position, consisting of a lap belt, two shoulder straps and an anti-submarine strap. A minimum six-point system is required for use in Cars where the Driver is seated in a semi-reclining position, consisting of a lap belt, two shoulder straps and two anti-submarine straps. FHR specific shoulder straps are permitted, but only when used in conjunction with an FHR device.

### 3 MATERIALS

- 3.1.1 The material of all straps shall be in good condition. The buckles shall be of metal-to-metal quick release type except in the case of the leg straps of the six-point system where they attach to the seat belt or shoulder harness straps.
- 3.1.2 Only separate shoulder straps are permitted. "V" and "Y" type shoulder straps are not allowed. "H" type configuration is allowed.

### 4 INSTALLATION

Details of installation shall be according to the manufacturer's instructions.

### 5 FUNCTION

All straps shall be free to run through intermediate loops or clamps/buckles.

### 6 HARDWARE

- 6.1.1 The minimum acceptable bolts used for mounting all belts and harness are 3/8in SAE Grade 5 or 5/16in Grade 8, which shall properly fit both the car mounting points and the belt end attachments. To achieve the required proper snug fit, shouldered steel bushings may be used if necessary. A Scrutineer shall approve, and note in the vehicle logbook, all installations using 5/16in bolts.
- 6.1.2 Where possible, seat belts, shoulder harness, and anti-submarine strap(s) should be mounted to the roll structure or frame of the Car. Where this is not possible, large diameter mounting washers or equivalent reinforcing shall be used to spread the load. Bolting directly to floor panels etc., without adequate reinforcement, is not acceptable.
- 6.1.3 All mounting hardware used to secure the driver restraint system shall serve no other purpose.



## 7 VALIDITY

- 7.1.1 Restraint systems meeting SFI standards shall bear a dated SFI spec label. For older labels with the punched manufacturing date, the certification indicated by this label shall expire on Dec 31st of the 2nd year after the date indicated by the label. Starting in 2017 the labels will use a printed expiration date ("Valid Until"); the equipment is not valid after the date printed.
- 7.1.2 Restraint systems homologated to FIA standards will have a label indicating a date of expiration which is Dec 31st of the year marked.
- 7.1.3 If a restraint system has more than one type of certification, the label with the latest expiration may be used.

DRAFT

## APPENDIX M – ROLL CAGES

### 1 GENERAL

#### 1.1 APPLICATION

Roll cages are mandatory on all Cars, unless otherwise stated.

#### 1.2 DESIGN

Roll cages may be of two designs, low front hoop (top of steering wheel or high front hoop (top of windshield). Specific installations are subject to the approval of the Chief Scrutineer at each Event. (Refer to Diagrams herein)

### 2 BASIC DESIGN CONSIDERATIONS

#### 2.1 PURPOSE

The basic purpose of the roll cage is to protect the Driver if the Car rolls over or is involved in a serious accident.

#### 2.2 INSIDE DIMENSIONS

The top of main hoop of the roll cage shall be a minimum of 2in above the top of the Driver's helmet when the Driver is sitting in a normal driving position, or shall be located as near the roof as possible in closed Cars. The top of the main hoop shall not be more than 10in behind the back of the Driver's helmet when the Driver is sitting in a normal driving position. A straight line drawn from the top of the main hoop to the top of the front hoop shall pass over the Driver's helmet.

#### 2.3 OPERATION

The roll cage shall be designed to withstand compression forces resulting from the weight of the Car coming down on the roll cage and to take fore/aft and lateral loads resulting from the Car skidding along on the roll cage.

#### 2.4 HEAD RESTRAINT

- 2.4.1 A system of head restraint to prevent whiplash and rebound and to prevent the Driver's head from striking the underside of the roll cage shall be provided.
- 2.4.2 The head restraint shall be capable of withstanding a force of 200 pounds in a rearward direction.
- 2.4.3 The headrest shall have a minimum area of 36 square inches and be padded with a non-resilient material such as Ethafoam or Ensolite or other similar material with a minimum thickness of 1in.
- 2.4.4 The head restraint support shall be such that it continues rearward or upward from the top edge of the pad such that the Driver's helmet cannot hook over the pad.
- 2.4.5 The padded surface shall touch the helmet and shall not be under fibreglass or other hard material.

#### 2.5 PADDING

Parts of the cage subject to contact with the Driver shall be padded with non-resilient material such as Ethafoam or Ensolite or other similar material with a minimum thickness of 1/2in.

## 2.6 AERODYNAMIC RESTRICTIONS

No portion of the roll cage shall have an aerodynamic effect by creating a vertical thrust.

## 2.7 ENGINE INTRUSION

Roll cage or chassis design shall prevent engine intrusion into the Driver compartment.

# 3 DIMENSIONS AND MATERIALS

## 3.1 MATERIALS

- 3.1.1 For cars built after March 31, 2020, the roll cage shall be of seamless or DOM mild steel tubing (SAE 1010, 1020, 1025) or equivalent, or alloy steel tubing (SAE 4125, 4130) **or Docol R8® tubing. When alloy steel tubing is used it must be normalized to relieve stress.**

***Provided proper manufacturers recommended welding practices are carried out during the welding process, such as preheat and post heat in the cases of 4125 and 4130, Docol R8® may be welded to other specified roll cage materials.***

ERW tubing will not be allowed for new cars built after March 31, 2020. Existing cars with ERW tubing used in the roll cage may continue to compete.

## 3.2 DIMENSIONS

Unless otherwise specified herein, the minimum size of tubing to be used shall be as follows (all dimensions are in inches):

<u>CAR WEIGHT</u>	<u>ALL MATERIALS</u>
Up to 1500 lbs.	1.375x0.095
1500-2500 lbs.	1.500x0.095
Over 2500 lbs.	1.500x0.120 or 1.750x 0.095

***For roll cages built and registered prior to March 31, 2022, the following is also permitted:***

<u>CAR WEIGHT</u>	<u>ALLOY STEEL</u>
<b><i>Up to 1500 lbs.</i></b>	<b><i>1.375x0.080</i></b>
<b><i>1500-2500 lbs.</i></b>	<b><i>1.375x0.095</i></b>
<b><i>Over 2500 lbs.</i></b>	<b><i>1.500x0.095</i></b>

ERW tubing for cars built before March 31, 2020 may use the following sizes only:

<u>CAR WEIGHT</u>	<u>ERW TUBING</u>
Up to 2500 lbs.	1.500x0.120
over 2500lbs.	1.750x0.120

## 3.3 WEIGHT

For purposes of determining tubing size, the Car weight is as raced, without fuel, Driver, or 'rewards weight'.

## 3.4 MINUS TOLERANCE

The minus tolerance for wall thickness shall not be more than 0.010 below the nominal thickness.

### 3.5 INSPECTION HOLE

An inspection hole of at least 3/16in diameter shall be drilled in a non-critical area of tubing to facilitate verification of wall thickness. The tubes to be inspected are:

- i. main hoop
- ii. fore and/or aft supports (as applicable)
- iii. front hoop (as applicable)

If a car is presented with the appropriate roll cage homologation papers and the cage is identified accordingly then inspection holes are not required.

## 4 FABRICATION

### 4.1 BENDS

One continuous length of tubing shall be used for the main hoop with smooth continuous bends and no evidence of crimping or wall failure. The radius of bends in roll cages (measured at centerline of the tubing) shall not be less than three (3) times the diameter of the tubing.

### 4.2 MAIN HOOPS

Whenever possible, roll cage hoops should start from the floor of the Car and in the case of tube frame construction, be attached to the chassis tubes by means of gussets or sheet metal webs with support tubes beneath the joints to distribute the loads. It is recommended that gussets be used at all joints.

### 4.3 JOINTS

All joints shall be fully welded. All welding shall be of the highest possible quality with full penetration and shall be done according to A.S.T.M. specifications for the material used. Arc welding, particularly heliarc, should be used whenever possible. Welds should be inspected by magnaflux or dye penetrant after fabrication. Alloy steels shall be normalized after welding.

### 4.4 BRAZING

Aluminum bronze or silicon bronze welding techniques are permitted, but extreme care shall be used in preparation of parts before welding and in the design of the attaching joints.

## 5 FORMULA AND SPORTS RACING CARS

### 5.1 GENERAL

- 5.1.1 Two-seat Sports Racing Cars shall have full cockpit width roll cages.
- 5.1.2 On Cars of full monocoque construction, a fabricated front hoop may be recognized by CASC-OR upon specific application.

### 5.2 MAIN AND FRONT HOOPS

- 5.2.1 On Formula Cars and single seat Sports Racing Cars the two vertical members forming the sides of the main hoop shall not be less than 15in apart, inside dimension, at their attachment points to the chassis. If the hoop does not go to the belly pan, it shall be attached to the chassis with proper gussets and tube triangulation to spread the loads. On monocoque chassis the main hoop shall be welded to mounting plates not less than 0.080in thick. These plates shall be attached to the chassis in a manner, which distributes the loads over a wide area. There shall be a plate of equal thickness on the inside of the monocoque with bolts of 5/16in minimum diameter through the non-ferrous material.

- 5.2.2 Low front hoops shall be no lower than the top of the steering wheel. If the hoop does not go to the belly pan, it shall be attached to the chassis with proper gussets and tube triangulation to spread the loads. NOTE: Some early model F1200, F1st, F1600, F2000 and F4 cars do not conform to this rule. These Cars may be recognized by CASC-OR on an individual exception basis only.
- 5.2.3 High front hoops shall be similar in shape to the rear hoop and have two horizontal tubes connecting the top of the front hoop to the top of the main hoop. In Cars with full height monocoque or composite construction (to top of steering wheel) a steel cap plate, not less than 0.080in thick shall be attached as a rubbing block.

DRAFT

### 5.3 BRACING

5.3.1 The main hoop shall have two fore/aft braces of tubing equal in dimensions and wall thickness to the tubing of the main hoop. This bracing shall be attached as near as practical to the top of the main hoop, no more than 6in below the top, and at an included angle of at least 30 degrees.

If these braces do not extend to the front hoop, an additional brace or gusset shall be installed at the point of attachment to the main rear roll hoop or lower frame rail, or other frame member, in such a manner as to reinforce the attachment point to help prevent collapse of the frame rail at the point of attachment. These tubes shall be 1.00in x 0.080in minimum and gussets shall be 3/16 in minimum.

5.3.2 Two seat Sports Racing Cars shall have a diagonal lateral brace of tubing equal in dimensions and wall thickness to the tubing of the main hoop to prevent lateral distortion of the main hoop.

5.3.3 Formula and single seat Sports Racing Cars under 1500lbs. may use bracing of tubing with a minimum dimension of 1.00in diameter and 0.080in wall thickness. When monocoque construction is used as bracing for a front hoop it shall be approved by CASC-OR on an individual basis.

5.3.4 If the fore/aft bracing is removable, the connection between the main hoop and the brace shall be of the double lug type fabricated from material at least 3/16in thickness and welded through a doubler or gusset arrangement to avoid distortion or excessive strains caused by welding. Details of the attachment of removable braces are shown in the diagrams herein.

5.3.5 It is recommended that the fore/aft brace, if removable, be attached to a rear chassis member through a double lug connection as described above. If attached to the engine, it shall mount to a major component such as a head stud or a combination of head studs.

## 6 ALL CLOSED-WHEEL CARS

### 6.1 GENERAL

6.1.1 Cars shall have full width roll cages either removable or welded to the Car. Roll cages shall be contained within the Driver/passenger compartment.

6.1.2 Removable roll cages shall be very carefully designed and constructed to be at least as strong as a welded installation. If one tube fits inside another tube to facilitate removal, the removable portion shall fit tightly and shall bottom on the permanent mounting, and at least two 3/8in diameter SAE grade 5 bolts shall be used to secure the joint. The telescope section shall be at least 8in in length.

### 6.2 MAIN AND FRONT HOOPS

6.2.1 The main hoop shall extend the full width of the Driver/passenger compartment.

6.2.2 The front and side hoops shall follow the line of the front pillars to the top of the windshield as close to the roof as possible then horizontally to the main hoop. A tube shall connect these two hoops over the top of the windshield.

Alternatively, a front hoop following the lines of the front pillars and connected to the main hoop on each side at the top may be used.

6.2.3 Open Cars without full windshields may have a low front hoop.

### 6.3 BRACING

6.3.1 The main hoop shall have two braces of tubing extending to the rear attaching to the frame or chassis. This bracing shall be attached as near as practical to the top of the main hoop, no more than 6in below the top, and at an included angle of at least 30 degrees. The main hoop shall have a diagonal brace to prevent lateral distortion.

6.3.2 Recommendations

- a) A horizontal lateral tube connecting the right and left legs of the main hoop, as close to the floor of the Car as possible, is highly recommended.
- b) A horizontal lateral under dash tube connecting the right and left legs of the front hoop is highly recommended.

- c) A lateral tube, shaped over the tunnel, connecting the bottom of the right and left legs of the front hoop is highly recommended. A vertical tube may be installed between the under-dash tube and this tube to strengthen the shaped section over the tunnel.

## 6.4 SIDE PROTECTION

- 6.4.1 Two horizontal tubes, or one horizontal tube and one angled tube, or a fully gusseted "X" brace, connecting the front and main hoops across the Driver's door are mandatory. Vertical tubes in this structure are highly recommended. Gussets shall be a minimum of 2 inches on the shortest side and made of plate steel twice the thickness of the tube wall, or formed from tubing of the same thickness and diameter as the cage, split and formed into gussets, or formed to a shape similar to the split tube from sheet steel the same thickness as the roll cage tubing. All gussets shall be fully welded all around.
- 6.4.2 One or more horizontal tubes or one diagonal tube connecting the front and main hoops across the passenger door are mandatory.
- 6.4.3 Interior door panels may be altered, replaced or removed to allow for installation of side protection tubes or NASCAR-style door bars. Where door panels are removed, all sharp edges or projections shall be protected.
- 6.4.4 If NASCAR-style door bars are installed, they should be constructed in the following manner:
  - They should be constructed of several horizontal tubes attached to the main and front hoop, angled out into the door cavity as far as possible, spaced equally at intervals no more than 15 cm center to center, with the top tube no lower than 1/3 of the height from floor to roof, but at no time higher than the top of the dashboard. Vertical tubes should be inserted between these tubes at equal intervals no greater than 30 cm center to center. A straight tube should be placed as close to the floor as possible but allowing the vertical tubes to connect from this tube to the lowest tube angling into the door.
- 6.4.5 The two lateral tubes recommended in Section 6.3 should be installed when a NASCAR-style door bar assembly is used.
- 6.4.6 All tubing shall be the same size as that which is specified for the weight of the car.

## 6.5 MOUNTING PLATES

- 6.5.1 Mounting plates shall be no thinner than 1/8in and no thicker than 3/16in with no single edge longer than 6in and with back-up plates of equal size and thickness on the opposite side of the panel with the plates through-bolted together using a minimum of three bolts per mounting plate. The minimum acceptable bolts shall be SAE Grade 5 of 3/8in diameter. Mounting plates may be welded to the car. Wherever possible the mounting plate should be shaped to and welded to a vertical portion of the car. Mounting plates shall not penetrate the firewall at any point. When the roll cage is attached to the floor, no contact plate on the Car shall measure less than 20 sq. in on any given plane.
- 6.5.2 On specific models of Cars where the floor construction will not permit a contact plate of this minimum area to be installed application shall be made to CASC-OR for a waiver to this rule. This will be noted in the Car logbook.

## 6.6 SEAT BACK MOUNTING

Seat backs shall be securely mounted and fastened. In order to provide secure seat back fastening, a section of tubing equal to the roll cage tubing shall be installed horizontally from the main hoop upright to the diagonal brace. This tube shall be no higher than shoulder height.

# 7 ALTERNATIVE ROLL CAGE DESIGNS

## 7.1 CERTIFICATION

The scrutineer may accept roll cages not complying with these specifications provided that the Entrant can produce a certificate complying with the following requirements:

- a) Load Certification: the certificate shall prove that the construction is capable of withstanding three simultaneously applied loads, the induced loads being carried over into the primary structure:
  - i. 1.5 (x) laterally;
  - ii. 5.5 (x) longitudinally in either direction;

- iii. 7.5 (x) vertically.  
(x) shall be the weight of the Car in starting order with the Driver aboard and full fuel tanks.
- b) Illustration: the certificate shall be accompanied by a drawing or photograph of the roll cage and shall be signed by a Professional Engineer or other qualified technical person recognized by CASC-OR.

## 7.2 COMPOSITES

Safety structures of composite materials shall be recognized on an individual basis by CASC-OR.

## 8 INCREASING ROLL CAGE HEIGHT

The following procedure is approved for increasing the height of existing roll cages not meeting the 2-inch helmet clearance requirement:

- a) The old main hoop shall be cut off near the chassis mounting and either a new main hoop of equal tube size or a section of equal sized tubing may be added.
- b) Inner tubing shall be used to mate all sections together.
- c) All braces shall be a maximum distance of 6 inches from the top of the hoop.
- d) The inner tubes shall be rosette welded at three points near the top and three points near the bottom. Refer to the diagrams herein.

## 9 ROLL CAGE DIAGRAMS

### 9.1 FORMULA CARS

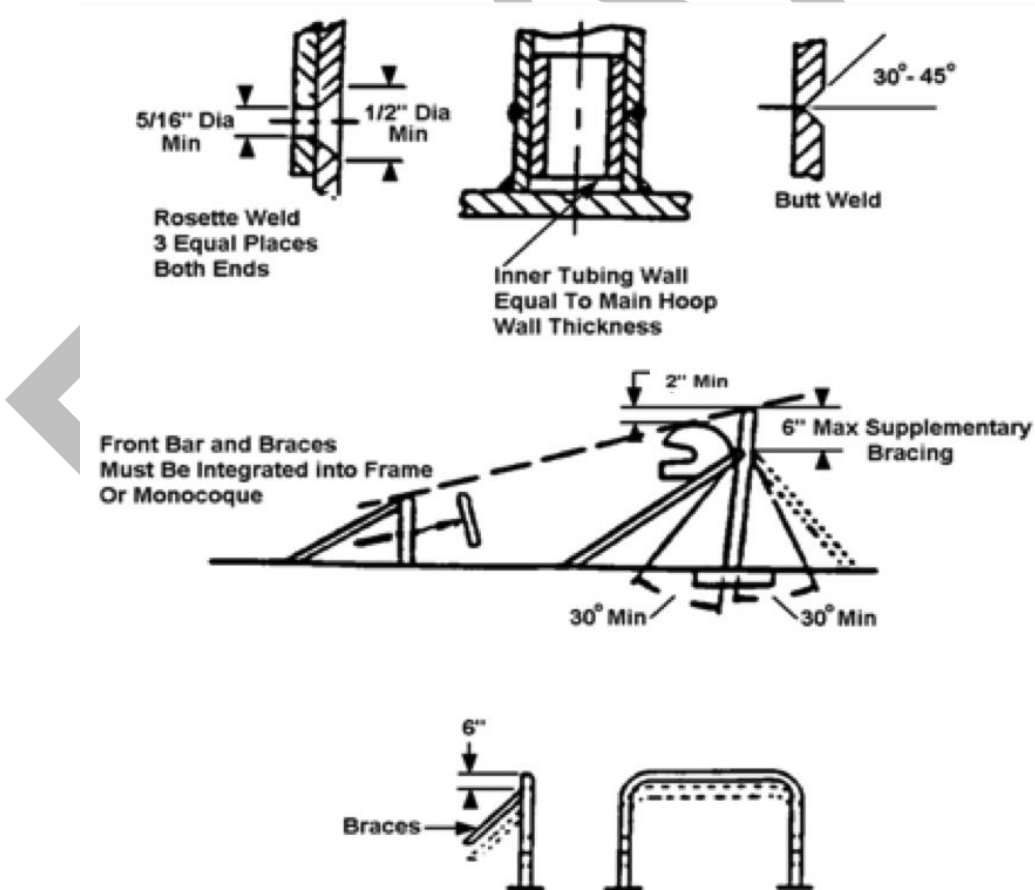



9.2 GT, OPEN GT CARS, AND SPORTS RACERS

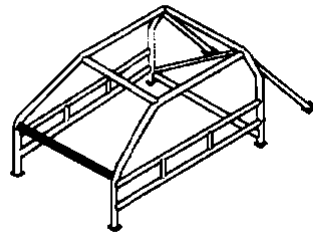
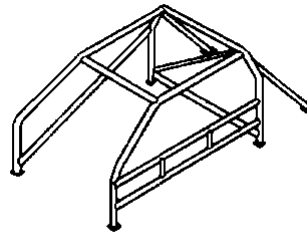
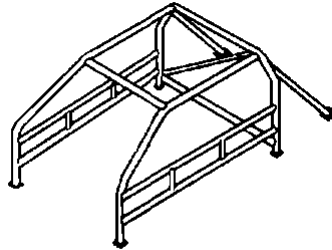
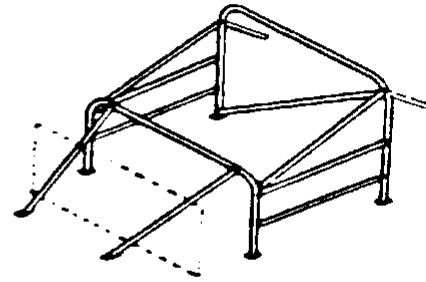
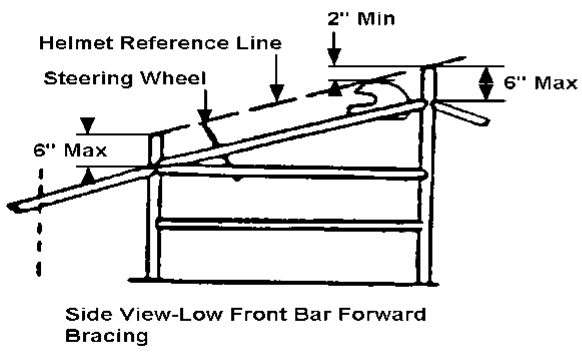

### 9.3 REMOVABLE BRACE DETAILS

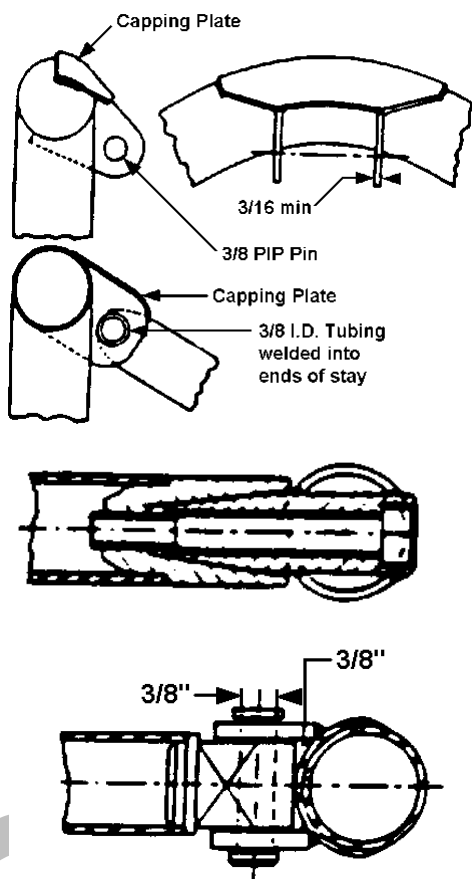

## APPENDIX N – CAR PREPARATION

### 1 SCOPE OF REGULATIONS

These Regulations and Specifications apply to all Cars in CASC-OR sanctioned Events.

It is the responsibility of the Driver/Entrant to ensure that the manufacturer's instructions for the installation, use and care of safety-related items are followed.

### 2 GENERAL PROVISIONS

- 2.1.1 To compete in a CASC-OR sanctioned Event; Cars shall comply with the GCR, with these Regulations and Specifications, and with the Class Regulations and Specifications.
- 2.1.2 If these Regulations and Specifications and Class Regulations and Specifications conflict, the Class Regulations and Specifications shall take precedence.
- 2.1.3 FIA homologated Cars will be dealt with on a case-by-case basis. The Entrant/Driver shall present homologation papers when the Car is scrutineered.
- 2.1.4 It is the responsibility of Entrants/Drivers to follow the manufacturer's recommendations for all safety equipment.

### 3 APPEARANCE

#### 3.1 PRESENTATION

Cars shall be neat and clean. Cars which are dirty either externally or in the engine and passenger compartments, or that show bodywork damage, or that are partially or totally in primer, or that do not bear the prescribed identification marks shall not be approved for Competition.

### 4 NUMBERS, MARKINGS AND ADVERTISING

#### 4.1 IDENTIFICATION NUMBERS AND CLASS DESIGNATORS

- 4.1.1 Cars shall carry identification numbers and class designators, or other marks required by the Regulations.
- 4.1.2 Any Competitor whose Car numbers are judged to be illegible by the Chief Timekeeper or the Clerk may be shown a 'Mechanical Black Flag' and shall not be scored or allowed to compete until the numbers are acceptable.
- 4.1.3 Cars shall have numbers which conform to the standards outlined below.
  - a) CLOSED WHEEL CARS
    - i. Numbers shall be placed on the front, rear, and on the driver and passenger's doors.
    - ii. These numbers shall be clearly visible to the timing tower of the circuit at which the Competition is taking place.
    - iii. Front numbers shall be no less than 250mm (10in.) high with a 50mm (2in.) stroke. Side numbers shall be no less than 250mm (10in.) high with a 50mm (2in.) stroke unless presented in black text on a white number plate, in which case they shall be no less than 200 mm (8in.) high with a 38mm (1 1/2in.) stroke.

- iv. Rear numbers shall be no less than 150mm (6in) high with a 38mm (1 1/2in) stroke.
- v. The distance between the digits shall be no less than the stroke of the digits.
- vi. A clear space shall be left around all numbers no less than 65mm (2.5in.) wide.
- vii. Class designators shall be no less than 100mm (4in.) high with a 13mm (1/2in.) stroke.
- viii. Class designators shall be placed on the driver's and passenger's doors as well as on the right-half of the rear of the car above the rear bumper and shall be clearly visible.

b) FORMULA AND SPORTS RACING CARS

- i. Numbers shall be placed on the front and both sides.
- ii. Numbers shall be no less than 200 mm (8in.) high with a 38mm (1 1/2in.) stroke unless presented in black text on a white number plate placed adjacent to the driver's shoulder, or on the rear wing end plate, and on the front in line between the front wheels, in which case they shall be no less than 150 mm (6 in.) high with a 25 mm (1 in.) stroke.
- iii. The distance between digits shall be no less than the stroke of the digits.
- iv. A clear space shall be left around all numbers no less than 50mm (2in.) wide.
- v. Class designators shall be no less than 100mm (4in.) high with a 13mm (1/2in.) stroke unless presented in an approved class panel. Approval shall be at the discretion of the Race Director.
- vi. Class designators shall be placed on both sides of the car adjacent to the side numbers.

c) VINTAGE HISTORIC and CLASSIC

- i. Cars shall display the standard class designator decals as supplied by VARAC on either side of the car, close to the car number.
- ii. Numbers, class designators and other marks required by the Regulations shall have a sharply contrasting background. It is HIGHLY RECOMMENDED that competition numbers shall be black on a white background of adequate area to accommodate the numbers.
- iii. Reflective/iridescent numbers are prohibited.

4.1.4 Car numbers shall be registered annually through the CASC-OR office via one of the following mechanisms:

- a) Any competitor with a registered number who has participated in a minimum of three (3) events in a season shall automatically have that same number re-registered for their use the following season.
- b) Any competitor with a registered number who has participated in fewer than three (3) events in a season can re-register that same number, if it remains available, upon receipt of payment for their Regional Race Driving Licence for the following season.
- c) An entrant who has multiple registered car numbers may retain those numbers provided that the total number of events in which that entrant's cars have participated divided by three is at least equal to the number of cars for which the request is being made. This shall not be an automatic process and the request shall be made at the end of the current competition season.

Appendix N – Car Preparation

- 4.1.5 For closed wheel cars, only numbers 02 to 09 and 1 to 299 shall be used for cars running for a Race Ontario Championship (See Appendix P).
- 4.1.6 Open wheel cars running for a Race Ontario Championship (see Appendix P) shall use numbers 02 to 09 and 1 to 99. When a car competes out of class it shall be the responsibility of that driver to change the number if there is a car already in the class with the same number.
- 4.1.7 Competitors who have non-registered numbers in an open-wheel class shall, where appropriate, use a non-conflicting car number higher than #99.  
  
Competitors who have non-registered numbers in a closed-wheel class shall, where appropriate, use a non-conflicting car number higher than #299.
- 4.1.8 Competitors who do not have CASC-OR registered numbers are not eligible for Championship Series points. They shall be assigned a number by the registrar when they enter the Event to avoid duplication within a race group.

**4.2 CASC-OR IDENTIFICATION**

Cars shall display the official CASC-OR logo unobstructed and prominently on both sides of the Car ahead of the side numbers. The logo shall be displayed on the front of the Car unobstructed and prominently near the front number or on the spoiler for Cars so equipped.

Sponsors' decals for all classes shall be displayed as outlined in a published bulletin.

Note: Decals must be located as close as possible to the illustrated locations.

4.2.1 GT SPRINTS, AND VARAC

Period livery correct cars exempt (VARAC).

Mandatory Decals		
CASC-OR Decal	1 each side, 1 on front	

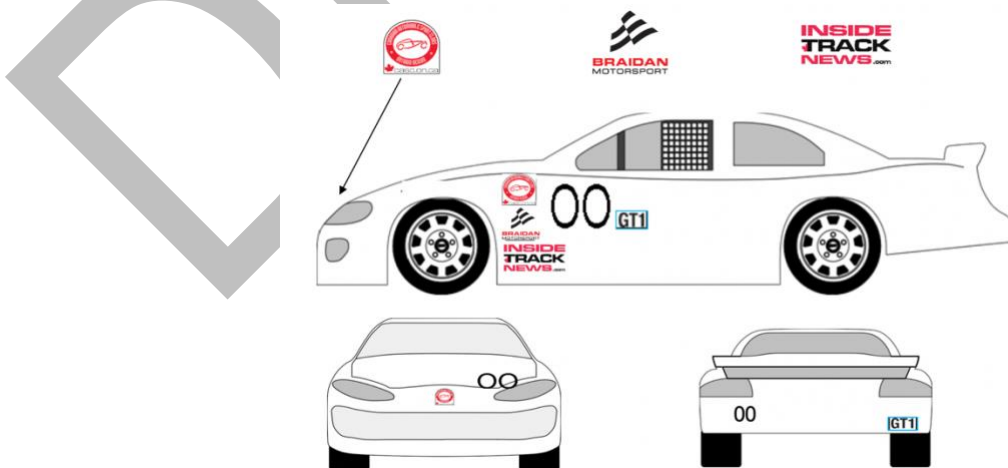

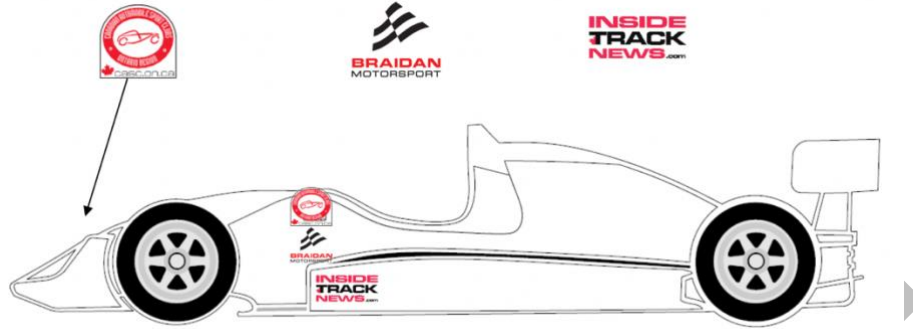

4.2.2 LIBRE, OPEN WHEEL, AND RADICAL CUP CLASSES

Mandatory Decals		
CASC-OR Decal	1 each side, 1 on front	



4.2.3 PIRELLI TIRE GT SPRINTS

Mandatory Decals		
CASC-OR Decal	1 each side, 1 on front	
CASC-OR Championship	1 each side	
Class Identifier	1 each side below or beside the number, and rear of car	

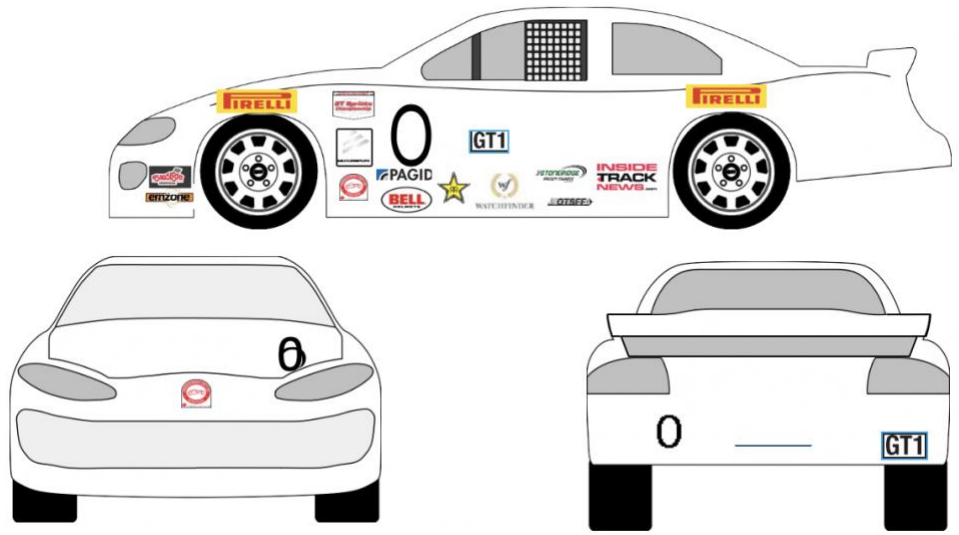

#### 4.3 ADVERTISING

Advertising, names and symbols may be displayed on Cars provided they are in good taste and do not interfere with identification marks.

### 5 SAFETY

#### 5.1 ROLL CAGE

Cars shall be equipped with a roll cage as specified in Appendix M – Roll Cages, hereto.

#### 5.2 DRIVER RESTRAINTS

Cars shall be equipped with seat belts and shoulder harness as specified in Appendix L – Driver Restraint Systems, hereto.

#### 5.3 WINDOW NETS

5.3.1 Window safety nets shall be installed on the Driver's side window of closed wheel Cars. (See Diagram "WINDOW NET INSTALLATION" herein).

5.3.2 The window net shall be equipped with a top-mounted quick-release device that, when activated, shall allow the net to fall down. If attached to the door rather than a roll cage the door shall be pinned shut.

5.3.3 WINDOW NET INSTALLATION

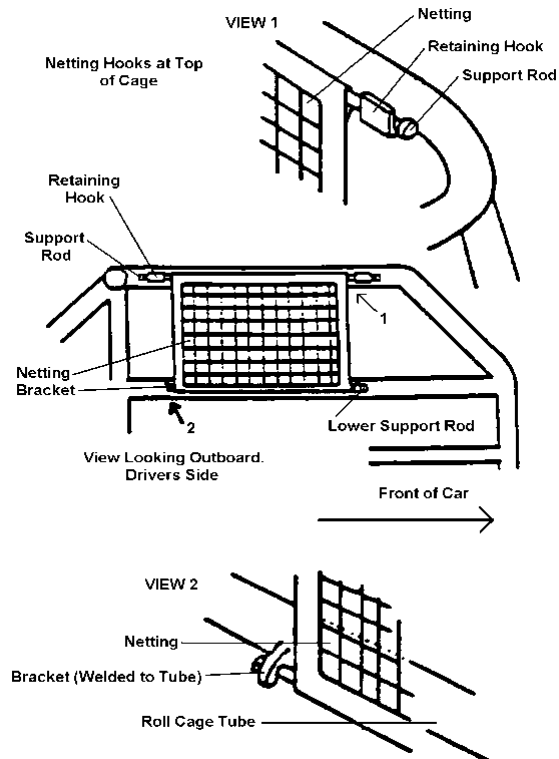

## 5.4 MASTER ELECTRICAL SWITCH

- 5.4.1 Cars shall be equipped with a general circuit breaker easily accessible from outside the Car. This master switch will cut all electrical circuits (ignition, fuel pumps, lights, alternator, etc.) but shall not affect the operation of an on-board fire extinguisher. All terminals of the master switch shall be insulated. The preferred type of circuit breaker is the red key model.
- 5.4.2 The location of the master switch shall be clearly marked by the official international marking - a red spark in a white-edged blue triangle and shall be mounted in the following standard locations. The OFF position shall be clearly indicated at the master switch location. Push or pull type switches must indicate how to set the "OFF" position, Pull for OFF, or Push for OFF labels must be in place. No other decals can be in the proximity (6 inches) of the master switch decal. The master switch shall be mounted in the following standard locations.
- 5.4.3 *Cars using a lithium-ion battery must display the green and black Lithium Battery decal near the master electrical switch. Cars without a master switch using lithium-ion batteries must display the green and black decal on the top of the driver side door near the window opening. Small lithium-ion batteries that power auxiliary devices within the vehicle (radios, cameras, data acquisition, etc.) do not require the decal to be displayed on the vehicle.***
- 5.4.4 **FORMULA and SPORTS RACING CARS:** In close proximity to the right-hand upright member of the main hoop and in a location so that it cannot be operated accidentally. It may be mounted on a bracket welded to the inside of the upright member of the main hoop.
- 5.4.5 **CLOSED WHEEL CARS:** On the driver's side of the car, in front of the windshield on either the cowl or fender but close enough to the windshield to be accessible if the Car is overturned. Alternatively, it may be mounted on a bracket attached by welding or clamps to the front hoop of the roll cage easily accessible through the driver's side open window. Drilling holes in the roll cage for this purpose is prohibited. The primary master switch shall be in plain view, not obscured by the door or window net. The switch shall be approximately 6 inches or less from the outside of the car.



To facilitate accessibility a second master switch or a remote actuator may be installed providing it duplicates and does not compromise the primary circuit breaker function.

## **5.5 SCATTERSHIELDS**

The installation of scattershields or explosion-proof bell housings is recommended where the failure of the clutch or flywheel could create a hazard to the Driver.

## **5.6 CHAIN-DRIVE CARS**

Chain drive Cars shall be fitted with a protective case/shield to retain the chain in case of failure. Minimum material specifications are:

- a) 0.125in SAE 4130 alloy steel
- b) 0.250in mild steel plate
- c) 0.250in aluminum alloy
- d) NHRA-approved flexible shields

## **5.7 DRIVE SHAFT LOOPS**

A minimum of 2 steel 360 degree "loops" per drive shaft section shall be installed of sufficient strength to prevent the drive shaft(s) from contacting the ground or injuring the driver in the event of shaft and/or U-joint failure. These loops shall be located as close as practical to each end of the drive shaft section(s).

## **5.8 ON-BOARD FIRE SYSTEMS**

It is recommended that Cars be equipped with on-board fire extinguisher systems.

## **5.9 FUEL CONTAINMENT**

All Cars shall be equipped with fuel cells/tanks conforming to Appendix K – Fuel, Fuel Cells and Tanks, hereto.

## **5.10 DRIVER TETHERING**

Other than driver restraints, any line, hose, wire, or other type of connection which could potentially tether a driver to a vehicle, shall be equipped with a breakaway device requiring no manipulation for its release. This device shall be designed and installed in such a manner that the action of the driver exiting the vehicle will cause separation thereby permitting unrestrained egress.

# **6 FORMULA CAR VISIBILITY**

## **6.1 GENERAL PROVISIONS**

- 6.1.1 Drivers of Formula Cars shall be able to see 90 degrees to either side (total of 180 degrees) with both eyes, by turning their head, but without lifting their head forward or otherwise moving from the normal driving position.
- 6.1.2 Polycarbonate or similar uncoloured transparent material may be substituted for existing bodywork. "Token" portholes do not satisfy this requirement. Only a structural member such as a roll cage brace or frame tube may interrupt the required field of vision.

## **7 WEIGHT**

### **7.1 GENERAL PROVISIONS**

All Cars shall meet or exceed the minimum weight as specified in class rules, exactly as they come off the course, at the conclusion of a Race or qualifying session.

### **7.2 BALLAST**

Ballast may be added to Cars as required, to meet minimum weight, provided it is securely mounted within the bodywork and serves no other purpose

## **8 FUEL**

Cars shall use fuel as defined in Appendix K – Fuel, Fuel Cells and Tanks, hereto.

## **9 BODYWORK**

### **9.1 POSITIONING**

All major body components such as front and rear hoods, fenders, doors and windshield shall be maintained in normal position throughout Competition.

### **9.2 FENDERS**

Fenders shall be securely mounted. Fender skirts and hubcaps shall be removed.

### **9.3 MIRRORS**

Mirrors shall provide Driver visibility to the rear of both sides of the Car.

### **9.4 DETACHABLE PANELS**

Detachable Hardtops, Panels and Detachable Doors (e.g., Lotus 7 doors) shall be removed or be permanently attached in a manner requiring tools for removal.

### **9.5 HOOD**

The hood and all parts in the engine compartment shall be securely fastened.

### **9.6 TONNEAU AND BOOT COVERS**

Tonneau covers and boot covers are prohibited except as allowed in Vintage rules hereto.

### **9.7 NOSE COVERS**

Hood/nose covers, "Bras", are prohibited.

### **9.8 SUNROOFS**

9.8.1 Sunroofs are permitted. The inside and outside of glass shall be taped. If there is an interior cover installed, it shall be securely closed at all times.

9.8.2 Sheet metal may be used to cover the exterior glass instead of tape provided the metal is properly secured.

## 9.9 T-BAR ROOFS

T-Bar roofs shall be removed and replaced with metal of the exact shape and dimension as the original pieces.

## 9.10 OPEN GT CARS

The top and frame shall be removed from all open (convertible) GT and Touring Cars.

## 9.11 DRIVER/PASSENGER COMPARTMENT

GT and Touring Cars shall have firewalls or other metallic separation isolating the driver/passenger compartment from the compartment(s) containing the fuel cell/tank, connections to the fuel cell/tank, fuel filler system, fuel pump(s), fuel discriminator valve(s) and the engine.

## 9.12 BUMPERS

Bumpers may be removed, except when they are an integral part of the coachwork, in which case they may be replaced with replicas of a different material. If the bumper is removed, all projecting hardware, brackets and fixtures shall be removed.

## 9.13 FENDERS

- 9.13.1 In order to provide clearance for wheels, tires and the installation of brake and oil cooler ducting, the interior of the fenders may be altered, except for the removal of panels separating the wheel wells from the engine, passenger, and/or luggage compartments.
- 9.13.2 The inner fender panels may be replaced with a panel of the same material and thickness as the original provided that the replacement provides the required separation.
- 9.13.3 Fender flares are allowed.

## 9.14 WINDOW TINTING

Windows shall be clear and uncoloured.

## 9.15 WINDOW MATERIALS

- 9.15.1 If window glass is removed it shall be replaced with polycarbonate.
- 9.15.2 Polycarbonate windshields shall be of 6 mm min. thickness and shall be identical in size and curvature to the original. These windshields shall have three inner straps to prevent them from collapsing inward. These straps shall be not less than 0.75in x 0.125in., of aluminum or material of equivalent rigidity. Spacing between these straps shall be a minimum of 8in.

## 9.16 WINDOW CLIPS AND REAR WINDOW STRAPS

- 9.16.1 Windshields retained solely by a rubber or pliable seal shall, in addition, be secured by five (5) clips, three at the top and two at the bottom, bolted or riveted to the body. These clips shall be 3in x 1in x 0.125in and made of aluminum or material of equivalent rigidity. The clips shall be spaced a minimum of 12in apart.
- 9.16.2 The installation of all other windshields other than OEM type bonded installations, shall be approved by a CASC licenced Scrutineer holding, or eligible to hold a Technical Inspection Stamp.
- 9.16.3 Rear windows, including those in hatches, retained only by a rubber or pliable seal shall, in addition, be secured with two straps of aluminum or material of equivalent rigidity, not less than 0.125in x 1in, bolted or riveted to secure structure above and below the window. The straps shall be spaced a minimum of 12in apart.

- 9.16.4 The installation of all other rear windows other than OEM type bonded installations, shall be approved by a CASC licenced Scrutineer holding, or eligible to hold a Technical Inspection Stamp.
- 9.16.5 Hatches, in addition to the provisions of 9.16.3 and 9.16.4 above, shall have a safety tether to prevent the hatch from opening more than approximately four (4) inches should the latch inadvertently release.

### 9.17 WINDSHIELDS FOR OPEN GT CARS

If the windshield on an open GT or Touring Car is removed a replacement windshield shall be fitted, not exceeding the height or width of the standard windshield and not extending rearward past a vertical plane at the rearmost part of the standard windshield/windshield frame. If the windshield is removed, the entire windshield (both halves of a divided windshield), including all brackets and mounting fixtures shall be removed.

### 9.18 AERODYNAMIC DEVICES FOR GT CARS

No part of any aerodynamic appendage may be wider than the widest part of the bodywork of the car.

## 10 TIRES

CASC-OR recognized tires, 190 km/h rating or higher are required where not specified by class regulations.

## 11 LIGHTS

### 11.1 BRAKE LIGHTS

GT Cars, Touring Cars, and Sports Racing Cars shall have two operating red brake lights which shall be functional and operational at all times and actuated only by application of the brake pedal. A minimum of 50 percent of the brake light area shall be exposed.

### 11.2 RAIN LIGHT

All cars shall have an FIA approved rain light. Notwithstanding this requirement, any car without this rain light may be approved if the light meets or exceeds the FIA standard as determined by the chief Scrutineer.

This light shall be illuminated when ordered by the Clerk.

### 11.3 FORMULA CARS

Formula Cars shall be equipped with a rain light as described in Section 11.2 above. This light shall be mounted on the centerline of the Car and be clearly visible from the rear.

The light shall be illuminated when ordered by the Clerk.

## 12 BRAKES

- 12.1.1 Brakes shall be pedal-operated, **or hand-operated for drivers with disabilities**, working on each wheel.
- 12.1.2 Cars shall have dual master cylinders and a dual circuit braking system so that effective braking is maintained on at least two wheels.

## 13 THROTTLE SPRINGS

A minimum of two throttle return springs are required. Electronic throttles are exempt.

## 14 EXHAUST

### 14.1 CATALYTIC CONVERTERS

Catalytic converters shall be removed.

### 14.2 EXHAUST SYSTEM TERMINATION

The exhaust shall terminate outside of, but not more than 100 mm beyond, the bodywork, exiting either to the side or the rear, behind a point equidistant between the front and rear hubs or behind the driver whichever is the further back, but in no case adjacent to or directly below the fuel filler. Any variation from this specification shall be approved in writing by the Regional Chief Scrutineer.

## 15 STARTERS

Cars shall be fitted with a self-starter capable of being operated by the Driver sitting in the normal driving position.

## 16 BATTERIES

16.1.1 Battery location is free within the bodywork. Flooded lead acid type batteries located in the driver/passenger compartment shall be in a non-conductive marine-type container or equivalent. The hot terminal shall be insulated.

16.1.2 All batteries shall be attached securely to the frame or chassis.

**16.1.3 All vehicles utilizing a lithium-ion main battery must indicate with a decal. See Section 5.4.3 above.**

## 17 OIL ACCUMULATORS/TANKS

17.1.1 Accumulators (e.g., Accusumps) may be installed. Location is free. They shall be securely mounted within the bodywork.

17.1.2 Oil tanks (dry sump tanks) located in the driver/passenger compartment shall be isolated from the driver by a metallic bulkhead(s) so that in the event of spillage, leakage or failure, oil will not reach the driver.

## 18 FUEL CAPS, LINES AND VENTS, OIL LINES, WATER LINES

### 18.1 LEAKAGE

No leakage of any fluid shall be allowed.

### 18.2 DRIVER/PASSENGER COMPARTMENT PLUMBING

All fuel and oil lines, including gauge and vent lines that pass into or through the driver/passenger compartment shall be of steel tube or metal braided hose (e.g., 'Aeroquip').

### 18.3 FILLER CAP

A positive locking fuel filler cap shall be used and fuel pick-up openings and lines, breather vents, and fuel filler lines shall be designed and installed so that if the Car is partially or totally inverted, fuel shall

not escape. If the fuel filler cap is located directly on the fuel tank, a check valve shall not be required provided the filler cap does not incorporate an unchecked breather opening.

#### **18.4 FLIP-TOP CAPS**

'Monza' (flip-top) gas caps are prohibited, except as allowed in Vintage rules.

#### **18.5 FUEL TANK AIR VENTS**

Fuel tank air vents shall vent outside the Car and shall not be vented through the roll cage structure.

#### **18.6 FUEL TANK VENTS IN OPEN GT CARS**

Fuel tank vents on open GT Cars shall be located at least 250mm behind the Driver.

#### **18.7 LOCATION OF FITTINGS**

It is recommended that all fuel lines, filler openings, and vents be incorporated in a single fitting located at the top of the fuel tank.

#### **18.8 ON FORMULA AND SPORTS RACING CARS**

18.8.1 Fuel filler necks, caps, or lids shall not protrude beyond the bodywork of the Car.

18.8.2 Fuel tank vents shall be located at least 250mm behind the cockpit.

#### **18.9 HEADER TANKS**

Header tanks located in the driver/passenger compartment shall be shielded.

#### **18.10 WATER LINES**

Water lines passing through the driver/passenger compartment shall be shielded or be of metal braided hose.

### **19 CATCH TANKS AND BREATHERS**

19.1.1 All engine crankcase breathers, whether directly or indirectly ventilating the crankcase, and all transmission/transaxle breathers shall be equipped with oil catch tanks.

19.1.2 Minimum catch tank capacity shall be one litre each for the engine and transmission/transaxle.

19.1.3 If a single catch tank is used for both the engine and the transmission/ transaxle; the minimum capacity shall be two litres.

19.1.4 Oil catch tanks shall not be mounted in the Driver/ passenger compartment. Dry sump system oil holding tanks may be mounted in the Driver/passenger compartment. A metal bulkhead shall prevent exposure of the driver to oil spillage.

19.1.5 Crankcase vacuum breathers that pass through the oil catch tank(s) to exhaust systems or vacuum devices that connect directly to exhaust systems are prohibited.

### **20 INTERIOR**

#### **20.1 SEAT MOUNTING**

Seats shall be securely mounted.

## **20.2 PASSENGER SEATBACKS**

Passenger seat back, if a folding seat, shall be securely bolted or strapped in place.

## **20.3 STEERING WHEEL MATERIALS**

Wood rim steering wheels are prohibited except as allowed in Vintage rules hereto.

## **20.4 ANCILLARY MOTORING EQUIPMENT**

Hubcaps, wheel trims, spare tires, jacks, tool kits and floor mats shall be removed.

## **20.5 INTERIOR TRIM**

It is recommended that interior trim, carpets, panels, stock seatbelts, and passenger seats are removed.

## **20.6 INTERIOR DOOR PANELS**

Interior door panels may be altered, replaced or removed to facilitate the installation of multiple sidebars (Driver intrusion protection). When interior door panels are removed, all sharp edges or projections shall be protected.

## **21 VENTILATION AND ACCESS**

GT vehicles shall run with the Driver front door window either fully open or fully closed. They shall be constructed to allow rapid egress on both sides of the vehicle.

When either door is permanently in the closed position, the window in that door shall be easily opened or removed from both the interior and exterior of the vehicle without tools.

## **22 FIREWALL AND FLOOR**

Firewall and floor shall prevent the passage of flame and debris to the Driver's compartment. Belly pans shall be vented to prevent the accumulation of liquids. All rear-engine Formula Cars shall have an undertray, from the Driver's foot area to the firewall.

## **23 AIR BAGS**

Air bags shall be removed if possible or shall be deactivated.

## **24 CRUISE CONTROLS**

Cruise controls shall be deactivated.

## **25 VIDEO EQUIPMENT**

In Car cameras or recording equipment is permitted provided the installation is recognized by the Event Chief Scrutineer and subject to the provision that the Stewards of the Event may impound any recording made during a track session. Drivers presenting recorded evidence in a Stewards' hearing shall provide the Stewards with the equipment necessary to view the recording.

## **26 RADIO COMMUNICATION AND TELEMETRY**

### **26.1 TELEMETRIC SIGNALS**

Excepting the receiving of standard broadcast radio signals, telemetric signals transmitted from or received by Cars during an on-track session are prohibited, unless prior written consent is received from

CASC-OR.

## 26.2 ALLOWABLE COMMUNICATIONS

Two-way voice communications is permitted between Driver and crew, when allowed by Series Regulations. In car voice communication between Drivers is not permitted.

## 26.3 RADIO COMMUNICATIONS

Radio communication systems used by Competitors shall not interfere with Race Control or any other Race Emergency radio networks. Competitors shall inform the Clerk of radio frequencies to be used prior to Competition.

## 26.4 MAGNETICALLY MOUNTED ANTENNAS

Magnetically mounted antennas shall be additionally secured with tape.

## 26.5 OEM ANTENNAS

External original equipment antennas shall be removed, or if retractable, shall be fully retracted.

## 27 TOWING EYES/TOW STRAPS

### 27.1 INSTALLATION

All cars without an exposed roll bar shall have a towing eye or strap, accessible from front and rear, which does not dangerously protrude from the bodywork when a car is racing, to be used for hauling the car. These towing devices shall be welded or bolted to the frame, roll cage or other significant structure. These towing eyes or straps shall be easily accessible and visible without removal or manipulation of bodywork or other panels. Towing eye minimum inside diameter shall be two (2) inches. Cars with tow points not clearly visible shall:

- a) have the tow point marked with high visibility paint;
- b) have a red arrow clearly indicating the location of the tow point;
- c) be within 12 inches of the rear or front of the car or be otherwise readily accessible, e.g., centrally located on the roof or attached to the roll bar.

27.1.1 For formula and sports racing cars that have bodywork covering the main roll hoop, there shall be an access hole allowing the car to be lifted by a hook or strap.

27.1.2 Effective January 1, 2017, cars being newly registered with CASC shall have towing eyes/tow straps that are visible on the front and rear of the car by a Scrutineer standing in front of and/or behind the car (not under the car)

27.1.3 Existing cars with a towing eyes/tow straps that do not meet this requirement and/or could possibly create a difficulty for the recovery/tow truck crew - in the opinion of the Chief Scrutineer - shall be required to change their towing eye/tow strap to comply.

27.1.4 Welds for towing devices shall be of the same quality as required on the main roll cage/hoop.

27.1.5 Tow eyes that are bolted shall be attached to the frame or other significant structure. The minimum acceptable bolts shall be SAE Grade 5 of 3/8 in diameter.

27.1.6 Tow straps shall come from a recognized manufacturer and shall be designed for motorsport application.

27.1.7 Wire cables are not acceptable.

## 28 SOUND LEVELS

The recommended acceptable level is 103 dBA or as specified in the Event Supplementary Regulations.



## **29 ANTIFREEZE**

The use of antifreeze (glycol) is prohibited.

## **30 TIMING TRANSPONDERS**

All cars shall be equipped with a functional AMB TranX 260 or MyLaps TR2 Car/Bike or MyLaps X2 Car/Bike transponder for timing purposes. The AMB X2 Pro and X2 Pro Plus are not supported at this time.

DRAFT

## APPENDIX O – REGULATIONS AND SPECIFICATIONS FOR CAR CLASSES

The following is a list of the regulations and specifications for car classes recognized by CASC-OR. Copies of these are available as separate publications on request from the Ontario Region office, or by free download from <https://www.casc.on.ca/road-racing/rules>.

- Section A: Formula 1200
- Section C: Formula 1600
- Section D: Formula 2000
- Section E: Formula Four
- Section F: PIRELLI Tire GT
- Section G: REMOVED
- Section H: Radical Canada Cup

DRAFT

## APPENDIX P – RACE ONTARIO SERIES REGULATIONS

### 1 GENERAL PROVISIONS

These Regulations cover the Race Ontario Championships series.

- a) Formula 1200
- b) Toyo Tires F1600
- c) PIRELLI Tire GT
- d) Radical Cup
- e) Formula Libre

### 2 SCHEDULE

To be published by bulletin.

#### 2.1 PUBLICATION OF EVENT SCHEDULES

Daily Event schedules are listed in the Event Supplementary Regulations.

#### 2.2 ATTENDANCE AT DRIVERS' MEETINGS

If a Drivers' meeting is scheduled, attendance is mandatory and may be checked by means of a roll call. Those not in attendance may be required to start at the back of the grid for their race.

### 3 ENTRIES

#### 3.1 OVER SUBSCRIPTION OF RACES

In the event of over subscription, the following actions shall be taken:

- a) Split the classes in a multi-class race.
- b) After the first race of the season, give preference to Competitors who have scored points in the current Race Ontario championships.
- c) Give first consideration to earlier entries.
- d) Reserve Entrants shall be notified of their status and may participate in practice/qualifying fulfilling all conditions set for regular entries.

#### 3.2 ISSUANCE OF SCRUTINEERING SHEETS

Where required Registrars shall issue an Event Scrutineering sheet to entrants, showing the Competition number and class of the Car entered.

#### 3.3 ISSUANCE OF NON-COLLECTIBLE PAYMENTS

- 3.3.1 Any Competitor giving a dishonoured method of payment to an organizing club for any fee shall be charged a \$25 handling fee plus any bank charges by the offended club in addition to the amount of the dishonoured payment.
- 3.3.2 Upon notification by an organizing club of an uncollectible fee from a Competitor, the club having made reasonable effort to collect it, CASC-OR shall take action as per Section 6.1.1 j of the GCR.

### **3.4 DATE OF PAYMENT**

The appropriate fee payable to the organizing club in Canadian funds shall be provided upon registration. Cheques may be dated the day of the Event.

### **3.5 ESTABLISHMENT OF ENTRY FEES**

The CASC-OR Race Committee shall set entry fees.

### **3.6 REFUND OF ENTRY FEES**

3.6.1 The organizing club shall issue a:

- a) Refund of the full entry fee less any applicable admin or credit card charges for any entry that is withdrawn before the on-track sessions commence at an event.
- b) Credit towards future entry fees equal to the full entry paid less \$100 if it is notified of the withdrawal of an entry prior to the start of the second session for that class.

3.6.2 Entries withdrawn after this time shall not be eligible for any refund.

3.6.3 Gate tickets are not eligible for refunds.

### **3.7 REFUSAL OF ENTRY**

The organizing clubs may refuse an entry with the prior approval of the CASC-OR Race Director or the CASC-OR Race Committee.

### **3.8 PARTICIPANT WAIVER**

All Participants, other than those licence holders with a current annual waiver on file with CASC-OR, shall sign the CASC-OR approved event waiver and shall display the identification issued to them at all times.

### **3.9 COMBINATION OF RACE GROUPS**

If there are less than 20 entries in a particular race group as of 12:00 PM Saturday classes or race groups may be combined differently than stated in the Event schedules.

## **4 COMPETITOR ELIGIBILITY FOR SERIES POINTS AND AWARDS**

### **4.1 COMPETITOR ELIGIBILITY**

4.1.1 To be eligible for Series Championship points, Competitors shall hold an approved Road Racing licence and must be a member of a CASC-OR affiliated club.

4.1.2 Also see Appendix E - Licences, Sections 1.2 and 1.4.

4.1.3 All cars must meet the car numbering requirements documented in Appendix N, Sections 4.1.5, 4.1.6, and 4.1.7.

### **4.2 PIRELLI TIRE GT**

4.2.1 To be eligible for the PIRELLI Tire GT Championship sponsorship funds the competitor shall register for the series using the appropriate Series registration form available at the CASC-OR website in the form section (<https://www.casc.on.ca/road-racing/rules>). Also see section 7.7 below.

4.2.2 The Competitor must use PIRELLI Tires except when a tire size waiver is issued by CASC-OR.

4.2.3 The Competitor must purchase the tires from the PIRELLI appointed tire supplier Braidan Motorsport.

4.2.4 The Competitor shall display all sponsorship decals as shown in the applicable diagram.

## **5 CAR CLASSIFICATION**

### **5.1 CAR CLASSES**

5.1.1 The following classes are eligible for the Race Ontario championships:

- a) Formula 1200 and Formula 1200 Masters
- b) Formula 1600 A and Formula 1600 B
- c) PIRELLI Tire GT: GT1, GT2, GT3, GT4, GT5
- d) Radical Cup
- e) Formula Libre: Formula 4, and Formula cars not listed above plus any formula, sports racers, or Radical Cup cars listed above choosing to participate in this class.

### **5.2 CHAMPIONSHIP IDENTIFICATION**

All Cars shall carry the required championship identification and have one CASC-OR decal prominently displayed on each side of the Car and one on the front. Decals are available from the CASC-OR office or the Event Chief Scrutineer. Failure to comply may result in forfeiture of accrued championship points.

### **5.3 BACK-UP CARS**

Back-up cars are allowed. Drivers who wish to change to a back-up car shall register this change and the car shall be scrutinized as per CASC-OR regulations. The back-up car shall start behind the last qualifier in the class.

## **6 COMPETITOR INFORMATION**

6.1.1 Location of competitor information, where qualifying and race results shall be posted shall be defined in the Supplementary Regulations.

## **7 POINTS**

### **7.1 SCORING**

Points scored in all Events shall count towards the championship for each class in the following series:

- a) PIRELLI Tire GT
- b) Formula Libre
- c) Formula 1200
- d) Radical Cup

7.1.1 Vintage Historic, Classic, and Formula Classic grids will be scored as per the VARAC rulebook.

7.1.2 Formula 1600 (each class) will be scored as follows:

<b>1<sup>st</sup></b>	30 points	<b>5<sup>th</sup></b>	12 points	<b>9<sup>th</sup></b>	7 points	<b>13<sup>th</sup></b>	3 points
<b>2<sup>nd</sup></b>	24 points	<b>6<sup>th</sup></b>	10 points	<b>10<sup>th</sup></b>	6 points	<b>14<sup>th</sup></b>	2 points
<b>3<sup>rd</sup></b>	19 points	<b>7<sup>th</sup></b>	9 points	<b>11<sup>th</sup></b>	5 points	<b>15<sup>th</sup></b>	1 point
<b>4<sup>th</sup></b>	15 points	<b>8<sup>th</sup></b>	8 points	<b>12<sup>th</sup></b>	4 points	<b>16<sup>th</sup> and on</b>	no points

To be eligible for Toyo Tires F1600 Championship points a competitor must register for the series through OFFC and hold a valid racing licence (e.g., CASC-OR, ASN Canada, SCCA) and must be a member of a CASC-OR affiliated club. All cars that complete 50% of the overall winner's distance (rounded up) will receive finishing points. There is 1 drop in a season (score 17 of 18 races). A competitor cannot drop a DQ.

## 7.2 RACE POINTS SCORING APPLICATION

This section is applicable only to:

- a) PIRELLI Tire GT (all classes)
- b) Formula Libre
- c) Formula 1200 (both classes)
- d) Radical Cup

### 7.2.1 QUALIFYING

All cars who attempt a qualifying run during the session will receive three (3) points.

### 7.2.2 STARTING A RACE

All cars who start the race will receive three (3) points.

### 7.2.3 FINISHING PERCENTAGE

- a) Finishing percentage

All cars that complete 50% of the class winner's distance (rounded up) will receive finishing points.

- b) Circuit Bonus

All drivers who compete in a Race Ontario points event at two of the three CASC-OR regional tracks will receive a bonus of 10 points towards the championship.

All drivers who compete in a Race Ontario points event at all three of the CASC-OR regional tracks will receive a bonus of 24 points towards the championship.

To be eligible for any bonus points, competitors must compete in a minimum of three CASC-OR events.

The three circuits are:

- Canadian Tire Motorsports Park
- Shannonville Motorsports Park
- Calabogie Motorsports Park

c) Up to Three Entrants

For a field consisting of three or fewer entrants, points will be awarded as follows:

Finishing Position	Qualifying	Starting	1 Starter	2 Starters	3 Starters
1	1 bonus	3	3	6	9
2	0	3	-	3	6
3	0	3	-	-	3

d) Four or More Entrants

For a field consisting of four or more entrants, points will be awarded as follows:

Finishing Position	Qualifying	Starting	Finishing
1	3 bonus	3	24
2	1 bonus	3	19
3	0	3	15
4	0	3	12
5	0	3	9
6	0	3	7
7	0	3	5
8	0	3	4
9	0	3	3
10	0	3	2
11 and remaining	0	3	1

7.2.4 SCORING INELIGIBLE COMPETITORS

For scoring, an ineligible competitor is a competitor who is registered to race in a CASC-OR class, but for other reasons are ineligible to receive points (see Section 4.1 above). Although the competitor will not receive points, any CASC-OR competitor who finishes behind an ineligible competitor will receive the points designated as if the ineligible competitor had scored points. For example, if the winner is ineligible for points, the second place would receive second place points, not first place points.

7.2.5 EVENT SCORING

The maximum accumulated points for an event shall be equivalent to a 3-race weekend. If a different number of races are scheduled (i.e., one, two or four), the maximum points will be distributed accordingly, such as 100% for one race, 50% for two races, or 25% for four races.

7.2.6 SEASON DEFINITION FOR THE PURPOSES OF SCORING

For points and scoring, the season begins on the morning of Saturday of the first CASC-OR race weekend of the current calendar year and concludes at the end of Sunday of the last CASC-OR race weekend of the current calendar year.

**7.3 CLASS SCORING - MINIMUM**

Competitors may count only one class score towards the CASC-OR RaceOntario Championship.

**7.4 CLASS SCORING - MAXIMUM**

Competitors may count points from all scheduled Events.

**7.5 CLASS SCORING – END-OF-YEAR SCORING**

Competitors must count a minimum of three (3) class scores to be eligible for end-of-year trophies. Note the definition of season in Section 7.2.5 above.

**7.6 SCORING TIES**

In the event of a tie, the Competitor scoring the greatest number of higher placings shall be declared the winner. If two or more competitors are tied after all placing tiebreakers have been used, the final tiebreaker will be the competitor that accomplished the higher placing first.

**7.7 POINTS FUND DISTRIBUTION – PIRELLI TIRE GT****7.7.1 YEAR END FUND DISTRIBUTION**

To be eligible to receive a payout from the PIRELLI Tire Year End Fund, drivers must compete in a minimum of 3 events.

The Year End Fund Distribution for each driver is computed from two components – a bonus for the finishing position in the championship, and the number of accumulated points.

The top three competitors (or first place only for classes with less than 4 entries) will receive a bonus. See the table below.

For the points distribution, each driver will receive a pro-rated percentage of the PIRELLI Tire Year End Fund, based on their total championship points in the PIRELLI Tire GT series.

Class with 4 or less entries			Class with between 5 and 9 entries			Class with 10 or more entries		
1 <sup>st</sup>	\$500	+ points money	1 <sup>st</sup>	\$600	+ points money	1 <sup>st</sup>	\$750	+ points money
2 <sup>nd</sup> and up		Points money	2 <sup>nd</sup>	\$300	+ points money	2 <sup>nd</sup>	\$500	+ points money
			3 <sup>rd</sup>	\$100	+points money	3 <sup>rd</sup>	\$250	+ points money
			4 <sup>th</sup> and up		Points money	4 <sup>th</sup> and up		Points money

For the purposes of an example, assume the accumulated points for all drivers who were eligible for the PIRELLI Tire Year End Fund was 5000 points. If the available Year End Fund was \$15,000 then each point would be worth 15000 / 5000, or \$3 per point. If a PIRELLI Tire GT class champion had accumulated 360 points and the class had 10 entries, then the driver would receive \$750 bonus for being 1st Place in a class of 10, plus \$3 x 360 for the pro-rated points, for a total of \$1830.



## **8 ANNUAL AWARDS**

### **8.1 PRESENTATION OF TROPHIES**

Trophies and Class Awards shall be presented by CASC-OR.

### **8.2 CAR NUMBER '1'**

The number "1" shall be awarded to the CASC-OR RaceOntario Sprints Champion for use in the following year's RaceOntario Sprints Championship.

### **8.3 ROOKIE AWARD**

This award shall be presented to a Driver starting the current year as a novice in road racing competition, and who, in the opinion of the CASC-OR Race Committee, is outstanding among his/her peers.

## **9 EVENT AWARDS**

### **9.1 TROPHY PRESENTATION**

The trophy presentation shall take place during the impound after the final race for each class grouping at the CASC-OR Scrutineering trailer, or other location designated by the organizing club.

### **9.2 CLASS REQUIREMENTS FOR AWARDING OF EVENT TROPHIES**

As a minimum, class trophies for the final races shall be awarded on the following basis:

- a) Where there are 8 or more entries-in-class, 1st, 2nd, and 3rd place trophies will be awarded.
- b) Where there are 5 to 7 entries-in-class, 1st and 2nd place trophies will be awarded.
- c) Where there are 1 to 4 entries-in-class, a 1st place trophy will be awarded.

### **9.3 ACCEPTANCE OF TROPHIES**

Trophies shall be picked up at the Event. They will not be delivered to Competitors.

## APPENDIX Q - ENDURANCE RACE REGULATIONS

### 1 GENERAL

These rules shall apply to all races designated as "endurance" races.

Entry fees, race length, curfew, awards and other items specific to an event shall be outlined in the supplementary regulations for that event.

### 2 ENTRIES

- 2.1.1 Each entry shall include one car, a maximum of three drivers, and a maximum of eight crew members who shall be listed on the entry form for that team.

### 3 DRIVERS' MEETING

Each Driver and Crew Chief shall attend the scheduled mandatory drivers' meeting. Failure to attend may result in the car starting the race from the back of the grid.

### 4 GRIDDING

- 4.1.1 Cars shall be gridded in the order of their best qualifying time. In the event of a tie the cars shall be gridded as set out in Race Regulations, Section 2.3.1 a).
- 4.1.2 It is the car which qualifies for the race, not the driver.
- 4.1.3 Either entered driver may start the car in the race regardless of who set the time.

### 5 PIT SET UP

Teams may begin staging or setting up equipment in pit lane as soon as the race immediately preceding the endurance race has been given the green flag. Teams entered in the endurance race shall allow teams and cars participating in the race in progress adequate room to use the pits during their race.

### 6 PIT PROCEDURES

#### 6.1 SIXTY (60) MINUTE RACES

- 6.1.1 All cars shall make a minimum 60 second (1 minute) pit stop no earlier than twenty (20) minutes after the start of the race and no later than forty (40) minutes after the start of the race.
- 6.1.2 In the event the race is stopped before its scheduled completion and cannot be restarted, drivers who have not made their mandatory pit stop shall have one lap deducted from their total laps completed.
- 6.1.3 Drivers may only refuel or store fuel in the pits during one-hour races under the direction of the Clerk of the Course.

#### 6.2 NINETY (90) MINUTE RACES

- 6.2.1 All cars shall make a 120 second (2 minute) pit stop no earlier than twenty (20) minutes after the start of the race and no later than twenty (20) minutes before the scheduled end of the race.
- 6.2.2 Refueling is permitted.

### 6.3 ONE HUNDRED AND TWENTY (120) MINUTE RACES

- 6.3.1 All cars shall make a 120 second (2 minute) pit stop no earlier than thirty (30) minutes after the start of the race and no later than ninety (90) minutes after the start of the race.
- 6.3.2 Refueling is permitted.

### 6.4 PIT PROCEDURES FOR RACES LONGER THAN 120 MINUTES

- 6.4.1 All cars shall make a 120 second (2 minutes) pit stop before the 90-minute mark of the race.
- 6.4.2 All cars shall make an additional 120 second pit stop for every complete hour beyond 2 hours (120 minutes) of scheduled race time, no later than 30 minutes past the start of the additional hour.
- 6.4.3 Refuelling is permitted.

## 7 ON-TRACK REPAIR

- 7.1.1 Trackside repair work may only be performed by the competitor who was driving the car when it was last running on track using only the tools, equipment and materials that were in the car when it stopped. If the corner marshals or the Clerk declare the position of the car to be "unsafe" no one may work on the car and the driver shall move to a "safe" location as directed by the marshals.

## 8 REFUELING

### 8.1 REFUELING EQUIPMENT

- 8.1.1 The following refueling equipment are permitted:
- Overhead refuelling rigs as per the **2022** ASN CANADA Regulations, Rule **24C** to **24M** and **24O** to **24Q**.
  - IMSA type rigs/hoses.
  - Approved cans with dry-break attachments.
  - Approved 5-gallon gasoline cans specifically manufactured for gasoline storage. Minor modifications specifically to reduce the chance of spillage are allowed with approval of the scrutineer.
- 8.1.2 Use of a funnel is prohibited.
- 8.1.3 One 10lb. dry chemical fire extinguisher that shall be presented to Scrutineering for inspection and approval. A sticker shall be affixed to the fire extinguisher indicating it has been approved for use and can include multiple car numbers if the extinguisher is to be used while refuelling multiple cars during the race.

### 8.2 REFUELING PROCEDURE

- 8.2.1 The crew chief shall inform a Pit Official that refuelling shall take place no earlier than 2 laps and no later than 3 laps from time of notification.
- 8.2.2 The driver shall shut off the car's engine, exit the car, and close the driver's side door before any refueler or refuelling equipment crosses the pit wall and before the fuel cap is removed.
- 8.2.3 No one may enter the vehicle, nor may any other action be performed on the car until the fuel cap is replaced and secured and all refuelling devices have vacated pit lane.
- 8.2.4 The engine may not be restarted until all work on the car is completed.

- 8.2.5 The refuelling team shall consist of two (2) people, one holding the approved 10lb. fire extinguisher and one refuelling. In addition, a third crew member can be utilized to operate the “dead-man” valve on an overhead rig, or holding the vent bottle for a dry-break system if these methods are used. No other person shall be in pit lane during refuelling.
- 8.2.6 All persons on the refuelling team and all persons who handle full or empty fuel containers shall wear approved driver’s protective clothing as per Appendix I – Driver Safety Equipment, Sections 2, 3, and 4. Work boots/shoes are acceptable alternate footwear. Full-face helmets with a closed face shield are required. Full-face helmets SA90 or newer otherwise meeting Appendix I – Driver Safety Equipment, Section 5, are allowed.
- 8.2.7 A maximum of 1 fuel container may cross the pit wall at a time. Additional team members may assist in passing fuel containers across the wall provided they are properly dressed as per Appendix G – Rules of the Pits and Paddock, Section 1.5.
- 8.2.8 All stored fuel containers shall have secure caps capable of preventing leaks if the container is overturned. Caps may be removed at any time, but only fuelers shall touch uncapped fuel cans whether empty or full.
- 8.2.9 All fuel containers (full or empty) shall be handled with care at all times e.g., fuel containers may not be thrown back over the wall.
- 8.2.10 A solid circular template of approximately 1290 square centimetres (200 square inches) shall be used to establish excessive fuel spillage. Use of a pan, tray or any type of absorbent material to catch spilled fuel is prohibited.
- 8.2.11 Refuelling shall be stopped immediately if any team member is observed not wearing the specified clothing or if proper refuelling procedures are not being followed. Refuelling shall continue only when the error is corrected.

## 9 PIT RULES

- 9.1.1 CASC-OR Race Regulations, Appendix G – Rules of the Pits and Paddock, apply with the following additions.
- 9.1.2 Cutting, welding or any equipment/repair involving open flame or sparks is not allowed in pit lane.
- 9.1.3 Generators are not allowed in the pits. Generators in the pit-service area shall be a minimum of six (6) metres distance from any fuel storage.
- 9.1.4 There shall be a minimum of one (1) pit official assigned for every five (5) pit boxes used.
- 9.1.5 Pit officials may require that substantial repairs be performed in the paddock. Repaired vehicles may return to competition under direction of a race official and with approval of the Clerk.
- 9.1.6 Pit officials shall monitor all aspects of the pit lane and refuelling rules.

## 10 PENALTIES

- 10.1.1 Competitors failing to make the mandatory pit stop may be black flagged and held in the pits for the designated length of the pit stop plus thirty (30) seconds.
- 10.1.2 All Black Flag penalties shall be carried out under green flag conditions as soon as possible after the infraction.
- 10.1.3 No penalty may be served while refuelling or repair is carried out. Failure to properly notify an official of the intention to refuel shall result in a 1-minute stop and go penalty.
- 10.1.4 Careless handling of any fuel equipment may be grounds for immediate expulsion from the race.
- 10.1.5 Fuel spillage considered excessive and reported to the Clerk may result in a Stop and Go penalty.

- 10.1.6 In the event the penalty is not enforced before the race is complete an appropriate time penalty shall be imposed by the stewards.

DRAFT

## APPENDIX Z - CHANGES SINCE PREVIOUS YEAR

Changes shown without a date are changes since the V3 2021 Race Regulations issued September 22, 2021. This summary is not considered part of the Race Regulations. Only the Race Regulations and Appendices A through Q are considered definitive.

### Race Regulations

Section 2.1.13 – Competitors have 5 minutes to complete their lap after checkered flag in race.  
Section 2.2.2c – Groups on a VARAC grid must follow the VARAC Conduct Procedures.

### Appendix B – Fees and Minimum Penalties

Section 2.7 – Penalties for a driver taking two checkered flags or not stopping appropriately for a red flag.  
Section 2.8 – Penalty for refusing to obey the instructions of an official.

### Appendix C – Glossary

Add definition of force majeure.

### Appendix G – Rules of the Pits and Paddock

Section 1.5 – Pit marshals may also wear white for visibility.  
Section 1.13.3 – Updated Blend Line infractions wording.

### Appendix H – Flags and Light Signals and Rules of the Road

Add Section 7.13 – Driving a Disabled Car to signal that they are disabled and allow following cars to pass.

### Appendix I – Driver Safety Equipment

Section 1.1.2 – The list of approval withdrawn equipment has been provided in a Bulletin posted on the CASC-OR web site.  
Section 2.6.1 – Remove BS6658 helmets. SA2010, SAH2010 and SA2015 helmets will expire end of 2023.

### Appendix L – Driver Restraint Systems

Section 1.1.1 – The list of approval withdrawn equipment has been moved to a Bulletin posted on the CASC-OR web site.

### Appendix M – Roll Cages

Section 3.1.1 – Added Docol® as a valid cage material.  
Section 3.2 – All new cages must follow the latest dimensions.

### Appendix N – Car Preparation

Section 5.4.3 & 16.1.3 – Vehicles utilizing lithium-ion main batteries must indicate with a decal.  
Section 12.1.1 – Brakes may be operated by hand-controls.

### Appendix O – Regulations and Specifications for Car Classes

Subsection A – Formula 1200  
Section 3c & 3d – Either 14" or 15" wheels are permitted.  
Section 4 – Either brake drum or brake disc conversions are permitted.

Subsection C – Formula 1600

Section 8.1.4 – There is a tire limit for both classes at Shannonville and Calabogie tracks.  
Section 16.7.8 – VTEC shall not activate below 5200 RPM.  
Section 16.1.5 – Restrictors will be tested using a No/No-Go gauge.  
Section 18.1.6 – Testing at a track 7 days prior to an event is not permitted.

### Appendix Q – Endurance Race Regulations

Section 8.1.1 – Updated the references to the 2022 ASN National Regulations for overhead rigs.